



## CTI Series

# Temperature & Sequential Valve Gate Controller User Guide



## Content

WARRANTY .....	- 4 -
SAFETY .....	- 4 -
CAUTIONS .....	- 5 -
Chapter 1 Introduction.....	- 5 -
1.1 CTI Series Mainframe Configurations .....	- 5 -
1.2 Control Modules .....	- 6 -
1.3 Specifications .....	- 6 -
1.4 Features .....	- 7 -
1.5 Typical Thermocouple & Mold Power Output Connector Wiring .....	- 8 -
1.6 Sequential Trigger & Output Connectors Wiring.....	- 8 -
1.7 Remote Input & Alarm Output Connectors Wiring .....	- 10 -
Chapter 2 Inspection & Installation .....	- 11 -
2.1 Unpacking and Inspection .....	- 11 -
2.2 Mounting the HMI (only for CTI-200 Series) .....	- 11 -
2.3 Connecting the HMI (Standalone HMI Only) .....	- 11 -
2.4 Connecting the Power Cable (CTI-200/CTI-300) .....	- 12 -
Chapter 3 Connecting the System to the Mold .....	- 13 -
3.1 Prior to Start Up .....	- 13 -
3.2 Verifying the Connection .....	- 13 -
3.3 Startup Procedure Checklist .....	- 13 -
Chapter 4 Operator Interface .....	- 15 -
4.1 Main Interface .....	- 15 -
4.1.1 Temperature Control.....	- 15 -
4.1.2 Temperature Zone Introduction.....	- 16 -
4.1.3 Multiple Temperature Zone Selection .....	- 17 -
4.1.4 Sequence Valve Gate Control .....	- 18 -
4.2 USB Port.....	- 19 -
4.3 RJ45 network port .....	- 19 -
Chapter 5 User Authority & System Setting.....	- 20 -
5.1 Login / Logout the System & User Authority .....	- 20 -
5.2 System Setting .....	- 23 -
5.2.1 Security .....	- 23 -
5.2.2 Time .....	- 26 -
5.2.3 Cabinet Temperature & ID .....	- 26 -
5.2.4 System.....	- 26 -
5.2.5 Language .....	- 26 -
5.2.6 Control Modules .....	- 27 -
5.2.7 Auxiliary Functions .....	- 27 -
5.2.8 42-zone / 24-zone Display Shifting .....	- 29 -
5.2.9 Clear Operation Log & Historical Data .....	- 29 -
5.2.10 Sensor Fault Solution .....	- 29 -
5.2.11 Speed Related Setting .....	- 30 -

- 5.2.12 Help..... - 32 -
- 5.2.13 Back ..... - 32 -
- Chapter 6 Temperature Control Operations ..... - 33 -**
  - 6.1 Control Modes ..... - 33 -
  - 6.2 Soft Start (dehumidify) Function ..... - 33 -
  - 6.3 Detail Parameters for Each Zone ..... - 34 -
  - 6.4 Zone Setting ..... - 36 -
    - 6.4.1 Operator Login Status..... - 36 -
    - 6.4.2 Engineer Login Status..... - 36 -
    - 6.4.3 Director / Administrator Login Status ..... - 37 -
  - 6.5 Group Config & Tools ..... - 39 -
    - 6.5.1 Group Setting ..... - 39 -
    - 6.5.2 Tools Management ..... - 40 -
    - 6.5.3 Back ..... - 43 -
  - 6.6 Graph ..... - 43 -
    - 6.6.1 Real-time Curve ..... - 44 -
    - 6.6.2 History Curve ..... - 44 -
  - 6.7 Alarms ..... - 48 -
    - 6.7.1 Alarm Record..... - 48 -
    - 6.7.2 Mute Function..... - 48 -
    - 6.7.3 Alarm Status..... - 49 -
  - 6.8 Simple Working Mode..... - 50 -
    - 6.8.1 Working mode selection. .... - 51 -
    - 6.8.2 Soft Start Setting ..... - 53 -
    - 6.8.3 Other Parameters Setting..... - 53 -
- Chapter 7 Sequential Valve Gate Control Operations ..... - 55 -**
  - 7.1 Control Modes ..... - 55 -
  - 7.2 Start Trigger Modes ..... - 56 -
  - 7.3 Gate Open/Close Trigger Modes ..... - 59 -
  - 7.4 Detailed Parameters for Each Gate ..... - 59 -
  - 7.5 Gate Setup ..... - 59 -
    - 7.5.1 Operator Login Status..... - 59 -
    - 7.5.2 Engineer / Director / Administrator Login Status..... - 60 -
  - 7.6 Test ..... - 61 -
  - 7.7 Preview the Setting..... - 61 -
- Chapter 8 Run/Stop System ..... - 62 -**
  - 8.1 Run System ..... - 62 -
  - 8.2 Stop System ..... - 62 -

## WARRANTY

We warrant that this product will be free from defects in materials and workmanship for a period of two (2) years from the date of shipment. If any such product proves defective during this warranty period, we, at our option, either will repair the defective product without charge for parts and labor, or will provide a replacement in exchange for the defective product.

This warranty shall not apply to any defect, failure or damage caused by improper use or improper or inadequate maintenance and care. We shall not be obligated to furnish service under this warranty; a) to repair damage resulting from attempts by personnel other than our representatives to repair or service the product; b) to repair damage resulting from improper use or connection to incompatible equipment; or c) to service a product that has been modified or integrated with other products when the effect of such modification or integration increases the time or difficulty of servicing the product.

**This warranty excludes replacement of fuses, triac, calibration, contact points and damage to the module from the use of improper styles of fuses. The maximum allowable fuse rating is 15 amps. Lower ratings may be used for improved protection.**

## SAFETY

Our products have been designed to be safe and simple to operate. As with any electronic equipment, you must observe standard safety procedures to protect both yourself and the equipment.

- Read all the instructions before connecting power and turning on the systems.
- Service and installation of this equipment should only be performed by qualified service personnel familiar with high voltage electrical circuits.
- All national and local electrical codes must be followed when connecting this equipment.
- Only persons with knowledge of the system's operation and capabilities should operate the system.
- Unless specifically explained in this manual or directed by us, do not attempt to repair the system yourself. Doing so could result in damage to the system, or serious personal injury.
- Do not apply voltage to a terminal that exceeds the range specified for that terminal.
- Do not connect thermocouples to any live areas of the heaters. Lock out and tag the controller and mold and make sure there is electrical insulation between the thermocouple and any live areas.
- Do not operate this product from a power source that applies more than the voltages specified.
- Do not operate this product with covers or panels removed. All unused slots of a main frame must be covered with the appropriately sized blank panels.
- Do not operate this product when wet.
- Do not operate this product in an explosive atmosphere.

## CAUTIONS

- When turning on the system, you should turn on all circuit breakers before power on the HMI. You may experience communication issues if you do not obey this sequence.
- After turning on the system, you should make sure that fans are running.
- Never allow the fan inlets or outlets on the unit become blocked. If these becomes blocked insufficient airflow can cause damage to the system.
- When switching off the system, you must wait 30 seconds before switching on. You may experience communication issues if you do not wait the required 30 seconds.

## Chapter 1 Introduction

### 1.1 CTI Series Mainframe Configurations

The CTI controller is made up of 3 different models of mainframes depending on the number of zones required. These are referred to as CTI-100, CTI-200, CTI-300.

All the mainframes utilize the same temperature control module CTI-M2, and the same sequence valve gate control module CTI-V6.

Access to all users' serviceable parts, including fuses, are done through the front of the controller by loosening the upper and lower screws on each heat sink and using the attached tool or screwdriver to lever the module out.

The connectors for the mold-power and thermocouple cables, and the connectors for valve gate control cables, are located at the rear of the mainframe.



## 1.2 Control Modules

The main frames are available with 2 styles of control modules depending on the requirements. The modules are fully interchangeable across all mainframe designs. The externally mounted heat sink and integrated design reduce maintenance cost and downtime.

Each CTI-M2 temperature control module comes standard with two zones at 15amps per zone. Each CTI-V6 sequence valve gate control module can control six valve gates each module. One or more power control modules are also required to supply the power requirements to the system solenoid valves. The position and quantity of power control modules and valve gate control modules in the mainframe are configured depending on the initial specification request, and are fixed to the specific slot position.

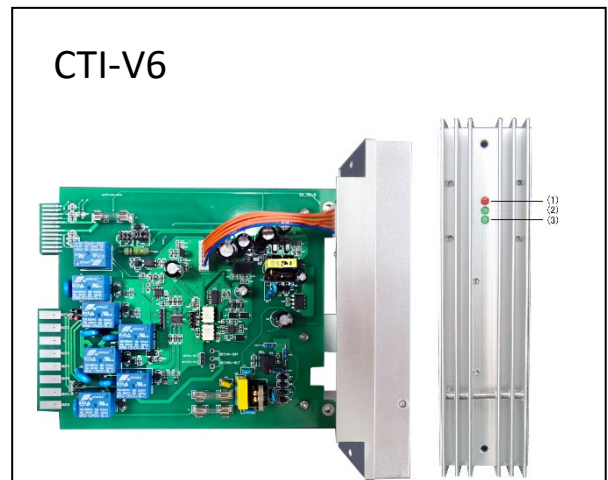
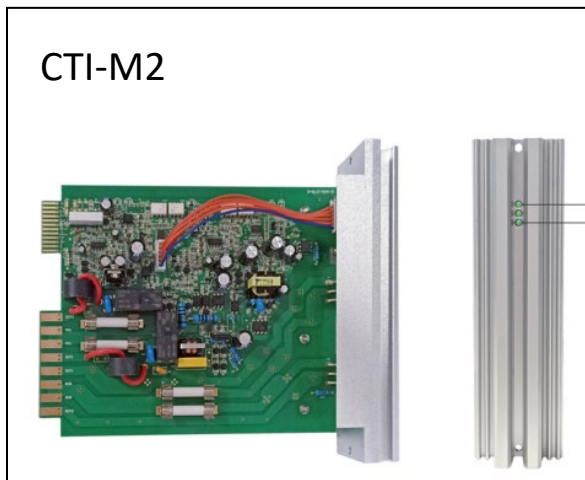

- (1) Power indicator: **green**, lighted when power on.
- (2)&(3) Zone A & Zone B status indicator
- green** – stop      **red** – running
- blink fast – communicating with HMI

- (1) Power indicator
- (2) Injection signal indicator
- (3) Output indicator

## 1.3 Specifications

Model	CTI-100	CTI-200	CTI-300
User Interface	Full color LCD touch screen		
Display Size	10.2"		
Max. Total Zones	32	80	120
Max. Temp. Zones	32	80	120
Max. Sequence Zones	24		
Power Supply	3-Ph+E(4 wire) 200-240Vac		
	3-Ph+N+E(5 wire) 380-415Vac		
Working Conditions	0~55°C (32~131°F), 10~80%RH (No condensing)		
Storage Conditions	-20~70°C (-4~158°F), 10~80%RH (No condensing)		

Temperature controller	CTI Series
------------------------	------------

Temperature Control			
<b>Control Mode</b>	Auto-PID / Manual	<b>Measurement Range</b>	0~500°C (32~932°F)
<b>Output Control</b>	Zero Cross / Phase Angle	<b>Setting Range</b>	0~450°C (32~842°F)
<b>Thermocouple</b>	J or K-Type, software selectable	<b>Temperature Unit</b>	°F or °C, software selectable
<b>Calibration Accuracy</b>	±0.25% FS	<b>Control Stability</b>	±1 digit-under steady state
<b>Load Capacity</b>	Rated 240Vac, 15A/zone	<b>Overload Protection</b>	Fuses on both heater legs
<b>TC Connector</b>	Varies options available	<b>Soft-Start</b>	Using low voltage for heater dehumidify
<b>Mold Power Connector</b>	Varies options available		
Sequence Valve Gate Control			
<b>Trigger Signal</b>	DC24V or Dry contact	<b>Trigger Mode</b>	4 modes selected
<b>Screw Position Signal</b>	DC 0~10V	<b>Screw Position Unit</b>	mm or inch
<b>Control Mode</b>	Auto / Manual	<b>Time Resolution</b>	1s, or 0.1s, or 0.01s
<b>Output Signal</b>	DC24V, or AC220V or Relay contact	<b>Output Connector</b>	Varies options available

## 1.4 Features

Cabinet	HMI
Temperature only, Sequential Valve Gate only, or Combination of both	Full color LCD touch screen
Max. 100 zones	English/Spanish/French
CE compliant	Fixed on mainframe or Stand-alone
Control Modules	Alarms & Protection
"All in one" control module	Sensor Broken /Reversed /Error
2-zone per temperature module (15 Amp per zone)	Load broken /shorted /over current
6-gate per SVG module	Over Temp / Under Temp
Other Functions	Fuse blown
Stopping system remotely (optional)	Heating invalid
Standby system remotely (optional)	Triac breakdown
All zones' temperature in tolerance output (optional)	Power supply over-voltage
Alarm output (optional)	Cabinet temperature over-setting
Sensor fault solution	Leakage

### 1.5 Typical Thermocouple & Mold Power Output Connector Wiring

The system can be supplied with either European style or US style power and Thermocouple mold connectors, typically wired as follows (Custom wiring available)

Thermocouple & Mold Power Combination Wiring

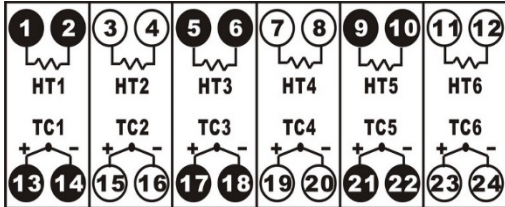

Wiring Mode 1

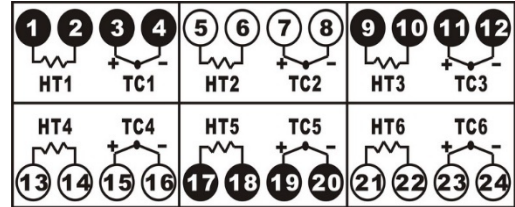

Wiring Mode 2

Thermocouple & Mold Power Separated Wiring

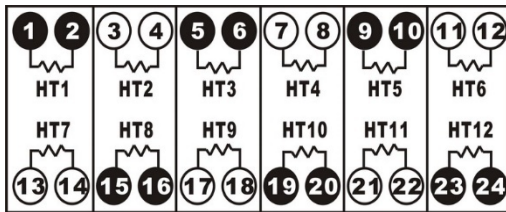

Wiring Mode 3

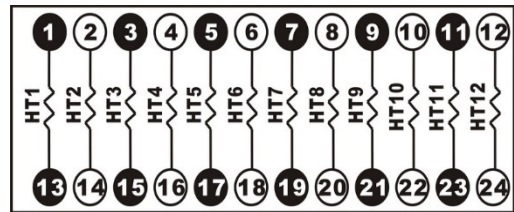

Wiring Mode 4

### 1.6 Sequential Trigger & Output Connectors Wiring

The valve gate sequence can be started by either a 24Vdc Trigger Input from the injection molding machine start cycle, or by a 0-10Vdc Screw Position source from the injection machine.

Valve Gate Input Wiring

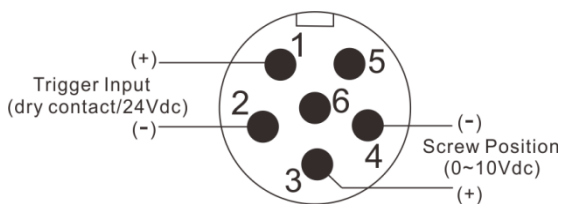



### Valve Gate Output Wiring (European style 24 pin series "A ")

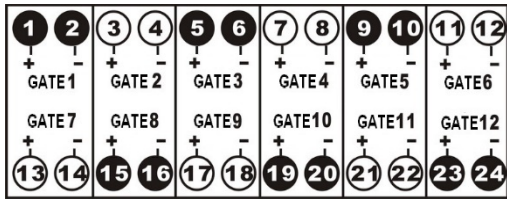

Signal	Pins	Description	Type
Trigger Input	1 & 2	Sees a closed condition or DC24V as a signal to start the timer on the valve sequence	Normally Open Dry Contact Or DC24V
Screw Position	3 & 4	Accepts a voltage source input that relates to the main screw position. A calibration routine within the controller adjusts actual input to actual screw position.	0 to 10 Volts

### Power Input Wiring

The CTI Temperature controllers can be connected to either 3-phase 4 wire type(200-240Vac) or 3-phase 5-wire type(380-415Vac) mains power supplies.

#### 3-Ph+N+E (5 wire) 380-415Vac

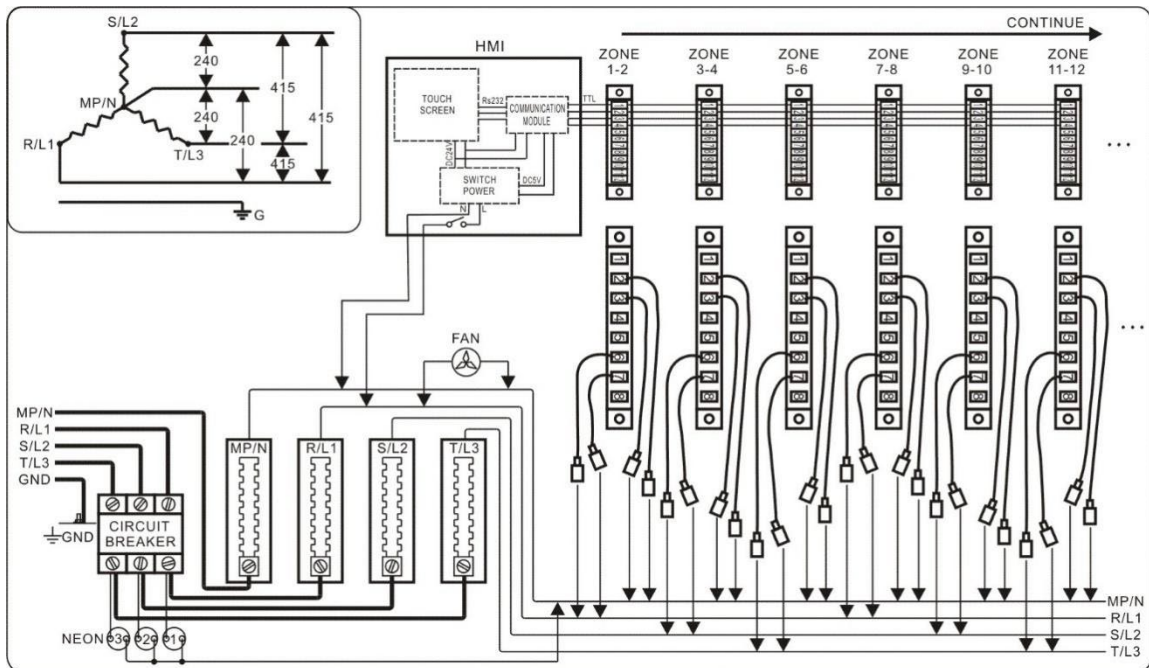

3-Ph+E (4 wire) 200-240Vac

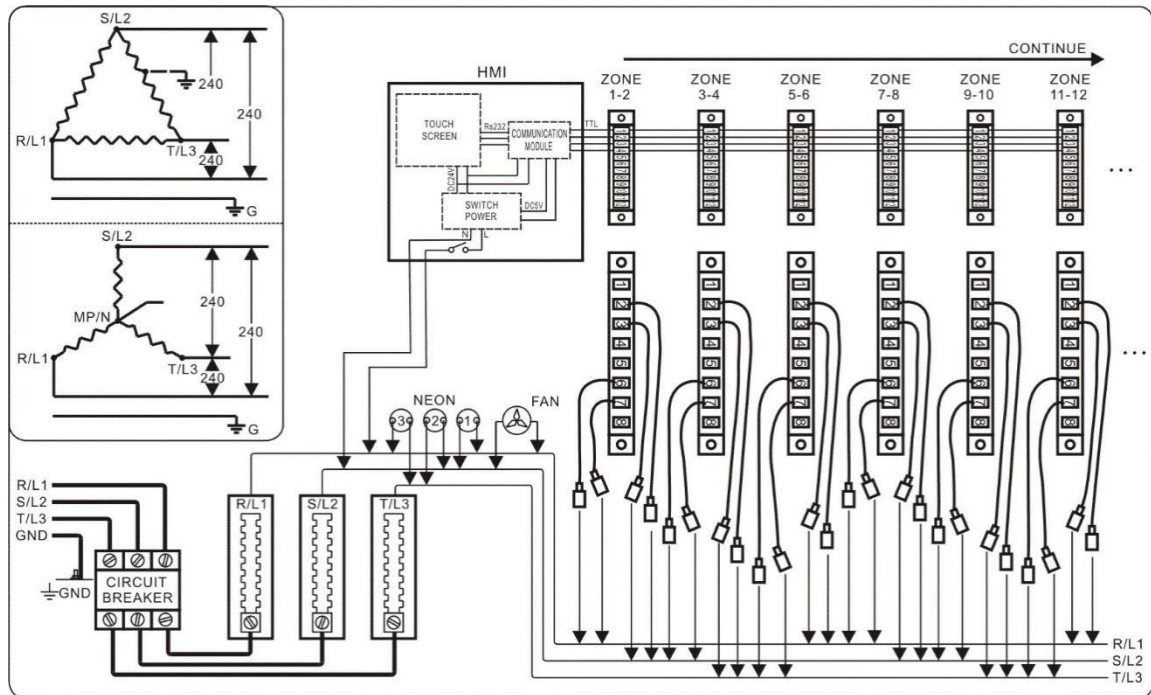

### 1.7 Remote Input & Alarm Output Connectors Wiring

(Where specified)

Remote Input Wiring

Alarm & Normal Output Wiring

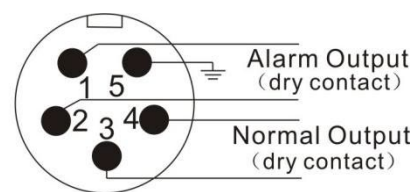
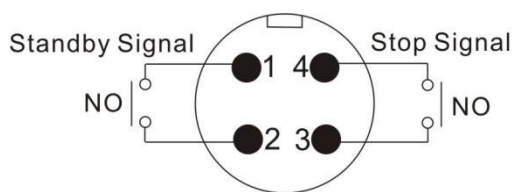

Signal	Pins	Description	Type
Standby Signal	1 & 2	After a delay time (adjustable) since the contact is closed, the controller will work in standby mode until AUTO button is pressed on HMI.	Normally open dry contact
Stop Signal	3 & 4	When the contact is closed, the controller will stop running, same as pressing STOP button on HMI.	Normally open dry contact
Alarm Output	1 & 2	Contact is closed when any alarm happens, and it will be reset by silence button on the alarm history page.	Normally open dry contact 1A/250Vac
Normal Output	3 & 4	Contact is closed when all zones' temperature are in normal output tolerance.	Normally open dry contact 1A/250Vac

# Chapter 2 Inspection & Installation

## 2.1 Unpacking and Inspection

1. After unpacking, inspect the mainframe and check for any damage that may have occurred during shipment.
2. Check the circuit breaker disconnect and neon phase voltage indicators for damage.
3. Check for proper operation of circuit breaker by flipping breaker on and off with no voltage applied.
4. Check connectors for any physical damage.
5. Check AC input power specification. The power specification label is located on the back cover of the mainframe's power input terminal block. The label indicates the input voltage configuration that was prewired at the factory. Make sure it matches what you ordered.
6. Inspect the HMI and check for any damage that may have occurred during shipment.
7. Check power connector/cable and communication connector/cable of HMI for any physical damage.

## 2.2 Mounting the HMI (only for CTI-200 Series)

1. Connect the HMI's power cable and communication cable to corresponding plug on the mainframe.
2. Mount the HMI on the mainframe by screws provided.

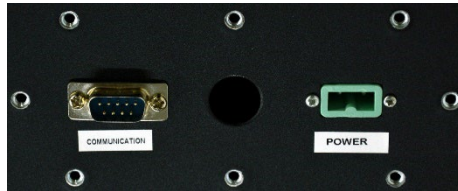

## 2.3 Connecting the HMI (Standalone HMI Only)

1. Place or mount the HMI on the position required.
2. Connect the HMI and the mainframe with communication cable.



## 2.4 Connecting the Power Cable (CTI-200/CTI-300)

1. Select the power input wire size according to the load power, and the national and local electrical codes. (if required)
2. Remove the metal cover of the power input terminal block by removing screws around its perimeter.
3. Remove the plastic panel of the terminal block.
4. Insert power input cable through access hole provided on the cover. (if use this type cover)
5. Connect AC input cord to the input terminal block as shown on the inner-side of cover, for the input voltage configuration you are attaching to.
6. Connect the earth cord to the ground terminal beside the input terminal block.
7. Cover the plastic panel on the terminal block.
8. Take up excess slack in cable and secure with strain relief clamp provided on the terminal block cover. (if use this type cover)
9. Mount the metal cover of the power input terminal block on the mainframe.



(1)

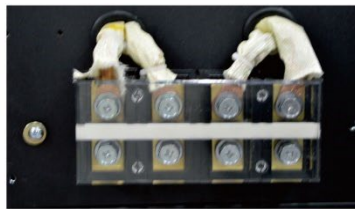

(2)



(3)



(4)



(5)

### CAUTIONS!

Service and installation of this equipment should only be performed by qualified service personnel familiar with high voltage electrical circuits.

All international and local electrical codes must be followed when connecting this equipment.

Should use O-type terminal on the power input cord connected to the terminal block.

Do not apply power to this cable or the unit when the back terminal block cover is removed.

Do not connect AC power input cord to your in-plant power distribution system until the back terminal block cover is securely in place.

Ensure that the chassis has been earth grounded before applying power.

## Chapter 3 Connecting the System to the Mold

### 3.1 Prior to Start Up

- Check that the system is completely disconnected from the power source.
- Clean up any water, oil, dirt, cleaning fluids etc. that may have spilled during a mold change or since the last production run.
- Check all the cable connections between the system and the mold (if required). Make sure all of the cables are free from wear or damage.
- Check that the earth/ground connection is in good condition. Verify the system and the mold have the same ground reference.
- Check the output power and thermocouple wiring configuration on the mainframe and cable is the same as on the mold.
- Confirm that the sequence valve gate control output meets the requirement of the solenoid valves.
- Confirm that the sequence valve gate trigger signal meets the requirement of the controller.

### 3.2 Verifying the Connection

1. Connect the thermocouple and mold power cables
2. Connect the sequence trigger signal cable and output cable (if required).
3. Using an Ohmmeter, touch one test led to the mold and the other to the mold ground terminal on the system. Resistance must be less than 1 $\Omega$ .
4. Check all the circuit breakers and make sure they are in the OFF position prior to connection of the controller to the power source.

### 3.3 Startup Procedure Checklist

1. Connect mold power & thermocouple cables, sequence control cables between the mold and controller (if required).
2. Connect the controller to the power source.
3. Switch the circuit breakers ON.
4. Turn on the HMI, then select the language.
5. Log in the system (if required).

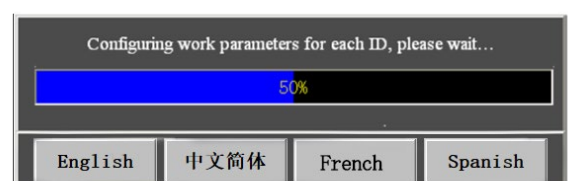

6. Load a mold setup (if required).
7. Checking the mold setup zone by zone on HMI.
8. Correct any faults found during diagnostics.
9. Touch "Run" to start the system.
10. Check that the controller is functioning correctly.

**IMPORTANT!**

When switching off the system, you must wait 30 seconds before switching on. You may experience communication issues if you turn off and, on the system, incorrectly.



# Chapter 4 Operator Interface

## 4.1 Main Interface

The main interface is used to monitor, log in the system and general operations.

### 4.1.1 Temperature Control













Icon Button Mode, 24 zone per page Resolution 0.1 is not checked

1 zone1 Stop 32 sv: 200 °C 0 % 0 A J	2 zone2 Stop 32 sv: 200 °C 0 % 0 A J	3 zone3 Stop 32 sv: 200 °C 0 % 0 A J	4 zone4 Stop 32 sv: 200 °C 0 % 0 A J	5 zone5 Stop 32 sv: 200 °C 0 % 0 A J	6 zone6 Stop 32 sv: 200 °C 0 % 0 A J	         	
7 zone7 Stop 32 sv: 200 °C 0 % 0 A J	8 zone8 Stop 32 sv: 200 °C 0 % 0 A J	9 zone9 Stop 32 sv: 200 °C 0 % 0 A J	10 zone10 Stop 32 sv: 200 °C 0 % 0 A J	11 zone11 Stop 32 sv: 200 °C 0 % 0 A J	12 zone12 Stop 32 sv: 200 °C 0 % 0 A J		
13 zone13 Stop 32 sv: 200 °C 0 % 0 A J	14 zone14 Stop 32 sv: 200 °C 0 % 0 A J	15 zone15 Stop 32 sv: 200 °C 0 % 0 A J	16 zone16 Stop 32 sv: 200 °C 0 % 0 A J	17 zone17 Stop 32 sv: 200 °C 0 % 0 A J	18 zone18 Stop 32 sv: 200 °C 0 % 0 A J		
19 zone19 Stop 32 sv: 200 °C 0 % 0 A J	20 zone20 Stop 32 sv: 200 °C 0 % 0 A J	21 zone21 Stop 32 sv: 200 °C 0 % 0 A J	22 zone22 Stop 32 sv: 200 °C 0 % 0 A J	23 zone23 Stop 32 sv: 200 °C 0 % 0 A J	24 zone24 Stop 32 sv: 200 °C 0 % 0 A J		
Tool:b		No Alarm		A:229V	B:229V	C:229V	2021/09/13 15:49:27

Icon Button Mode, 42 zone per page Resolution 0.1 is checked

1 Stop PV: 30.0 sv: 200 °C	2 Stop PV: 30.0 sv: 200 °C	3 Stop PV: 30.0 sv: 200 °C	4 Stop PV: 30.0 sv: 200 °C	5 Stop PV: 30.0 sv: 200 °C	6 Stop PV: 30.0 sv: 200 °C	         	
7 Stop PV: 30.0 sv: 200 °C	8 Stop PV: 30.0 sv: 200 °C	9 Stop PV: 30.0 sv: 200 °C	10 Stop PV: 30.0 sv: 200 °C	11 Stop PV: 30.0 sv: 200 °C	12 Stop PV: 30.0 sv: 200 °C		
13 Stop PV: 30.0 sv: 200 °C	14 Stop PV: 30.0 sv: 200 °C	15 Stop PV: 30.0 sv: 200 °C	16 Stop PV: 30.0 sv: 200 °C	17 Stop PV: 30.0 sv: 200 °C	18 Stop PV: 30.0 sv: 200 °C		
19 Stop PV: 30.0 sv: 200 °C	20 Stop PV: 30.0 sv: 200 °C	21 Stop PV: 30.0 sv: 200 °C	22 Stop PV: 30.0 sv: 200 °C	23 Stop PV: 30.0 sv: 200 °C	24 Stop PV: 30.0 sv: 200 °C		
25 Stop PV: 30.0 sv: 200 °C	26 Stop PV: 30.0 sv: 200 °C	27 Stop PV: 30.0 sv: 200 °C	28 Stop PV: 30.0 sv: 200 °C	29 Stop PV: 30.0 sv: 200 °C	30 Stop PV: 30.0 sv: 200 °C		
31 Stop PV: 30.0 sv: 200 °C	32 Stop PV: 30.0 sv: 200 °C	33 Stop PV: 30.0 sv: 200 °C	34 Stop PV: 30.0 sv: 200 °C	35 Stop PV: 30.0 sv: 200 °C	36 Stop PV: 30.0 sv: 200 °C		
37 Stop PV: 30.0 sv: 200 °C	38 Stop PV: 30.0 sv: 200 °C	39 Stop PV: 30.0 sv: 200 °C	40 Stop PV: 30.0 sv: 200 °C	41 Stop PV: 30.0 sv: 200 °C	42 Stop PV: 30.0 sv: 200 °C		
Tool:b		No Alarm		A:229V	B:229V	C:229V	2021/09/13 15:49:27

- **Function Button:** Icon mode is the default setting. Text mode can be selected on system setting page.
- **24 or 42 zones per page:** 24-zone is the default setting, can be alternated on system setting page
- **Resolution:** 1 is the default setting, 0.1 can be selected on system setting page

-  **[Run]:** (green) Run selected zones or all zones of temperature & valve (if no zones selected)
  -  **[Stop]:** (red) Stop selected zones or all zones of temperature & valve (if no zones selected)
  -  **[Auto]:** Place all zones or selected zones run in Auto mode.
  -  **[Standby]** Place all zones or selected temperature zones in Standby mode. In standby mode, the control target value is 70% of set value.
- Note:** Currently display set value remains the same
-  **[PgUp]:** Used to view the previous page.
  -  **[PgDn]:** Used to view the next page  
On the last page, you will see  **[SVG]**
  -  **[SVG]:** Shift to the sequence valve gate control interface
  -  **[Alarm]:** Used to view the alarm record.
  -  **[Group]:** Enter the group parameter setting, pattern/mold files management, and language selected.
  -  **[Setting]:** Used to enter the system setting and working mode setting interface.
  -  **[Login] / [Logout]:** Used to log in/out the system to achieve the different authority.

#### 4.1.2 Temperature Zone Introduction

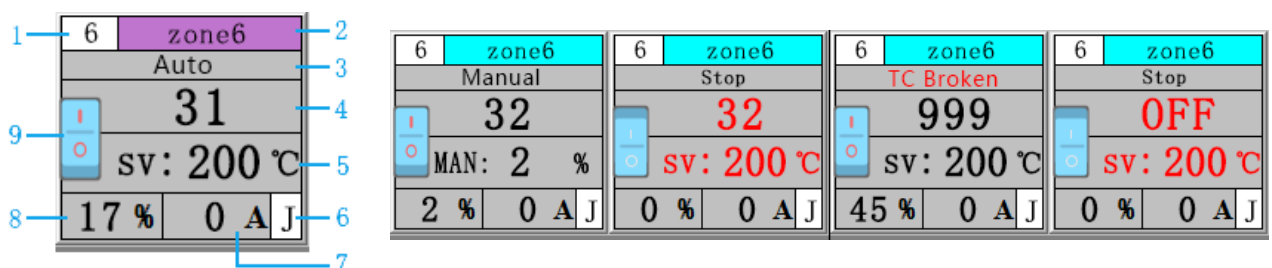

- 1. Zone number:** Current temperature zone ID number, cannot be modified.
- 2. Zone name:** Current temperature ID name can be customized; default background is blue.  
This temperature zone name customization needs supervisor or above authority.
- 3. Zone status:** Auto, Stop, Standby, Manual, Alarm (display in red)
- 4. Present Temperature Value (PV):**
  - resolution 0.1 can be selected on system setting page.



- displayed in **red** color in stop state
- if thermocouple is open, 999 will be displayed
- if zone is turned off, **OFF** is displayed in red color
- blinking when communication fails
- Touch it to set zone's parameters and operate it.

#### 5. Setpoint (SV):

- temperature unit can be selected between **Celsius and Fahrenheit** by Engineer's parameter.
- displayed in **red** color in stop state
- output percent setting will be displayed in manual mode
- Touch setting value, output percent and load current can be alternated to show in 42-zone page

6. **Sensor type:** can select J-type and K-type in zone setting or group setting

7. **Load current:** display current real-time output current value

8. **Power output percentage:** display the current real-time power output percentage

9. **Temperature zone on/off button:** control single temperature zone on and off directly

### 4.1.3 Multiple Temperature Zone Selection

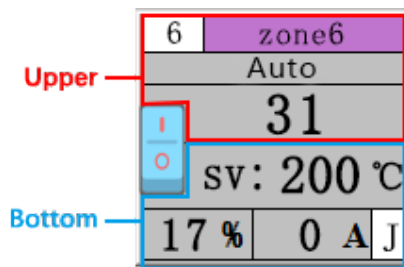

**Touch different sections of the temperature zone for different actions.**









**Section 1:** Touch the upper half part of the zone, enter temperature zone setting.

**Section 2:** • Touch the bottom half part of the zone, select current zone (zone blinking).

- Touch again to cancel selection
- Select multi zones, users can execute batch operation of on/Stop/Auto/Standby
- And can execute group operation (modify general parameters)

Note: The selected zone will keep blinking all the time if no operation or modify parameters

## 4.1.4 Sequence Valve Gate Control

1	GATE1	2	GATE2	3	GATE3	4	GATE4	5	GATE5	6	GATE6	    <b>Test</b>     	
7	GATE7	8	GATE8	9	GATE9	10	GATE10	11	GATE11	12	GATE12		
13	GATE13	14	GATE14	15	GATE15	16	GATE16	17	GATE17	18	GATE18		
19	GATE19	20	GATE20	21	GATE21	22	GATE22	23	GATE23	24	GATE24		
Tool:b		No Alarm				A:229V		B:229V		C:229V		2021/09/13 15:49:27	

 **[Stop]**: (red) Stop valve gate control of all zones.

 **[Run]**: (green) Run valve gate control of all zones.

 **[Auto]** / **[Manual]**: Place the valve gate control of all zones in Auto / Manual mode.  
Each gate can be opened or closed by manual, usually used for system debugging.

 **[Temp]**: Shift to the temperature control interface

**TEST** **[TEST]**: Used to simulate the trigger signal to test all valve gates control.

 **[Graph]**: Used to view the open & close sequence setting of all gates.

 **[Alarm]**: Used for viewing the alarm record.

 **[Group]**: Enter the group/global setting, pattern/mold files management, and language selection.

 **[Setting]**: Used to enter system setting.

 **[Login]** / **[Logout]**: Used to log in/out the system to achieve the different authority.

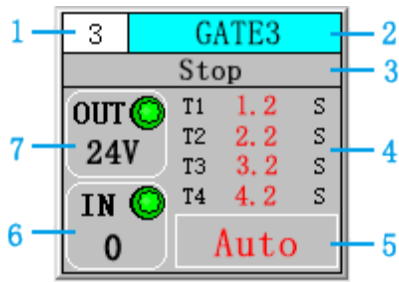

1. **Gate Number:** Current valve ID number, cannot be modified
2. **Gate Name:** Current valve ID name, can be modified
3. **Gate Status:** Run, Stop, Manual
4. **Gate Setting value:** Display in red color under setting status and black color under working status
5. **Control mode:** Auto, Manual, OFF
6. **Input signal lamp and screw position:** screw position's unit is mm or inch, selected in screw position's calibration
7. **Output signal and type:** 24V or 220V

**Note:** For lamps in 6/7, no signal show **green** lamp; signal generates shows **red** lamp.

## 4.2 USB Port

The USB port on the CTI series is intended to be used to copy mold setup files to and from the system. The screen for importing or exporting mold setups is displayed in the Group Setup Screen.

These mold setup files can be copied to other CTI controllers that support the same file type.

The USB port is also be used to export the historical data record (in csv format) from the system. The screen for exporting data record is displayed in the History Data Curve Screen.

### CAUTION!

- Never power on the unit with a device in the USB port.
- Never connect a powered USB hub or other device to the USB port.
- Removing the USB disk from the system during read or write operation could cause data corruption to the USB disk contents that could result in bad files or the entire drive from being usable.

The following warnings and restrictions should be observed when using the USB port:

- Only supports USB disks that use a File Allocation Table (FAT or FAT32) format.
- Only supports USB versions 2.0 and 1.1.
- Use an empty USB disk or one that contain as few files as possible.

## 4.3 RJ45 network port

The RJ45 network port on the CTI series controller is used for Internet networking, supporting network port networking and MODBUS TCP communication protocol.

It supports remote reading of system operating status and working parameters, remote start/stop of the system, remote single stage start/stop, and remote modification of the temperature target value.

## Chapter 5 User Authority & System Setting

### 5.1 Login / Logout the System & User Authority

To avoid accidental changes and protect the system data, the controller is set up with different operator levels which have different security authorities.

To achieve the corresponding authority, the operator should login the system by their security group name and password before operation.

#### 5.1.1 Login / Logout the System

- The main interface displays  [Login] when no user login. Touch the icon and enter the Login interface, select the corresponding username and input password to login the system.

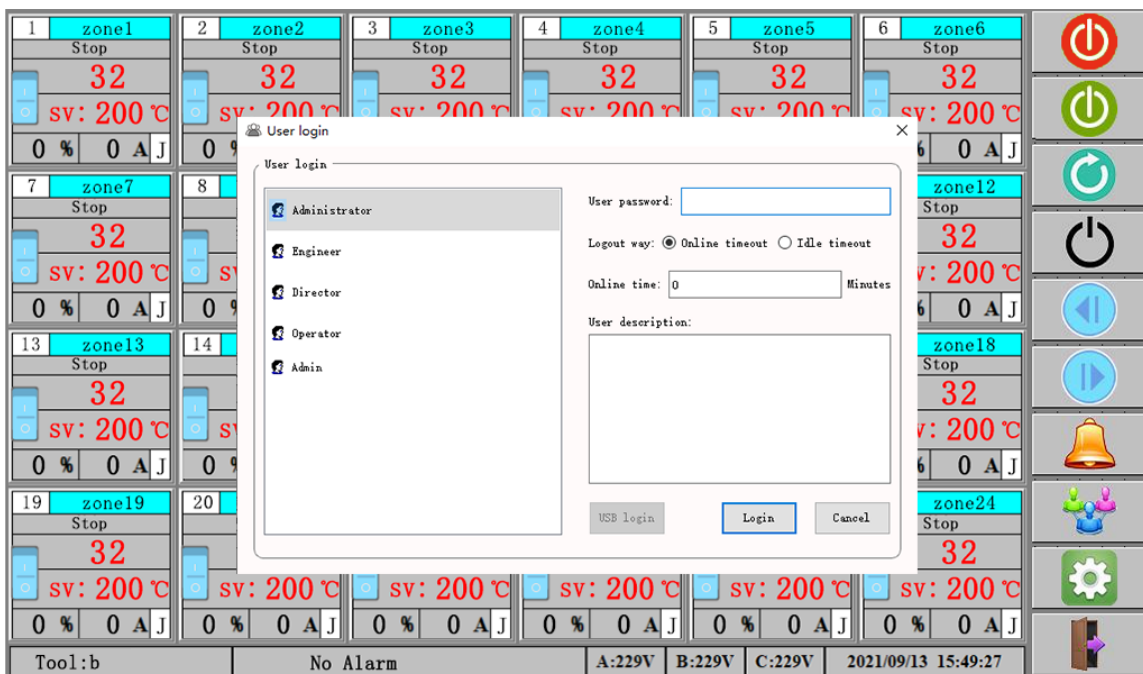

- The main interface displays  [Logout] when user login. you can Touch the icon and choose "Yes" to log out the current user.

- Set 'timeout logout' automatically. After inputting password, you can choose Logout type, "Online timeout" and "Idle timeout". You can set the time, for example, 10 minutes. If no operation after 10 minutes, the system will turn to be non-login status.

### 5.1.2 User's Authorities List

User Group	Authorities	Remarks
Non-Login	<ul style="list-style-type: none"> <li>• View data only, can't operate</li> <li>• Visit alarm records</li> </ul>	
Operator	<ul style="list-style-type: none"> <li>• All authorities of non-Login</li> <li>• Run, Stop the system</li> <li>• Choose zone, set Auto, Standby mode</li> <li>• Modify temperature set value</li> <li>• Select 24/42-page display</li> <li>• Modify Operator password</li> <li>• View module types, status, help interface</li> </ul>	Username: "Operator" Initial password: "1"
Engineer	<ul style="list-style-type: none"> <li>• All authorities of Operators</li> <li>• Manage all operator users</li> <li>• Modify all parameters of all zones</li> <li>• Select system language</li> <li>• Set system time and date</li> <li>• Group management</li> <li>• Choose manual mode, set power output %</li> <li>• Set thermocouple fault solution</li> </ul>	Username: "Engineer" Initial password: "321"

	<ul style="list-style-type: none"> <li>● Set data storage interval time</li> <li>● Relieve alarm buzzer</li> <li>● View history curve, export data</li> <li>● View system log, operation records</li> </ul>	
Director	<ul style="list-style-type: none"> <li>● All authorities of Engineers.</li> <li>● Manage operator and engineer users</li> <li>● Modify zone id, set zone color</li> <li>● Select display resolution etc.</li> <li>● Open / close zone</li> <li>● Set PID auto-tuning, Boost</li> <li>● Clear data records</li> <li>● Set auxiliary functions</li> </ul>	Username: "Director" Initial password: "654321"
Admin	<ul style="list-style-type: none"> <li>● All authorities of director</li> <li>● Manage operator, engineer, director users</li> <li>● Select OAID display (for maintenance)</li> </ul>	Username: "Admin" Initial password: "87654321"
Super Admin	<ul style="list-style-type: none"> <li>● All authorities of admin</li> <li>● Manage all users</li> </ul>	Username: "Administrator" Password kept by seller

## 5.2 System Setting

Touch icon  [System] on the main interface of temperature control, then enter the System Setting Screen.

**System Setting:** Cabinet Temp: 28 °C ID: 24

**Security:**

Users

Password

Login to Run/Stop

Max ID: 120

With SVG/IO

**System:**

Data Record:

0 Min

Auto Page:

0 Sec

System Log

**Control Modules:**

ID	Status	Type
1	online	Temperature
2	online	Temperature
3	online	Temperature
4	online	Temperature
5	online	Temperature
6	online	Temperature
7	online	Temperature
8	online	Temperature
9	online	Temperature
10	online	Temperature

**Time:**

2023 Y

4 Mon 6 D

11 H 22 Min

**Language:**



English

中文简体

French

Spanish

Software version: 4.32



Aux

42P



T/C Fault Solution

Startup Group

### 5.2.1 Security

- **Authorization:**

You can manage users, include add, copy and delete users.

You can also check the user's properties.

The User group name can be edited.

There are 4 User Groups: operators, engineers, directors, admins.

Each group has different authorities. You can create more than one user in each group.

**Operator:** Authorized to use the functions related to production process.

**Engineer:** Authorized to use all functions except auxiliary functions

**Director:** Authorized to use all functions except OAID display for maintenance

**Admin:** All authorities (admin cannot be deleted)

- **Change Password:** You can change the password for the current user by “Edit user”.

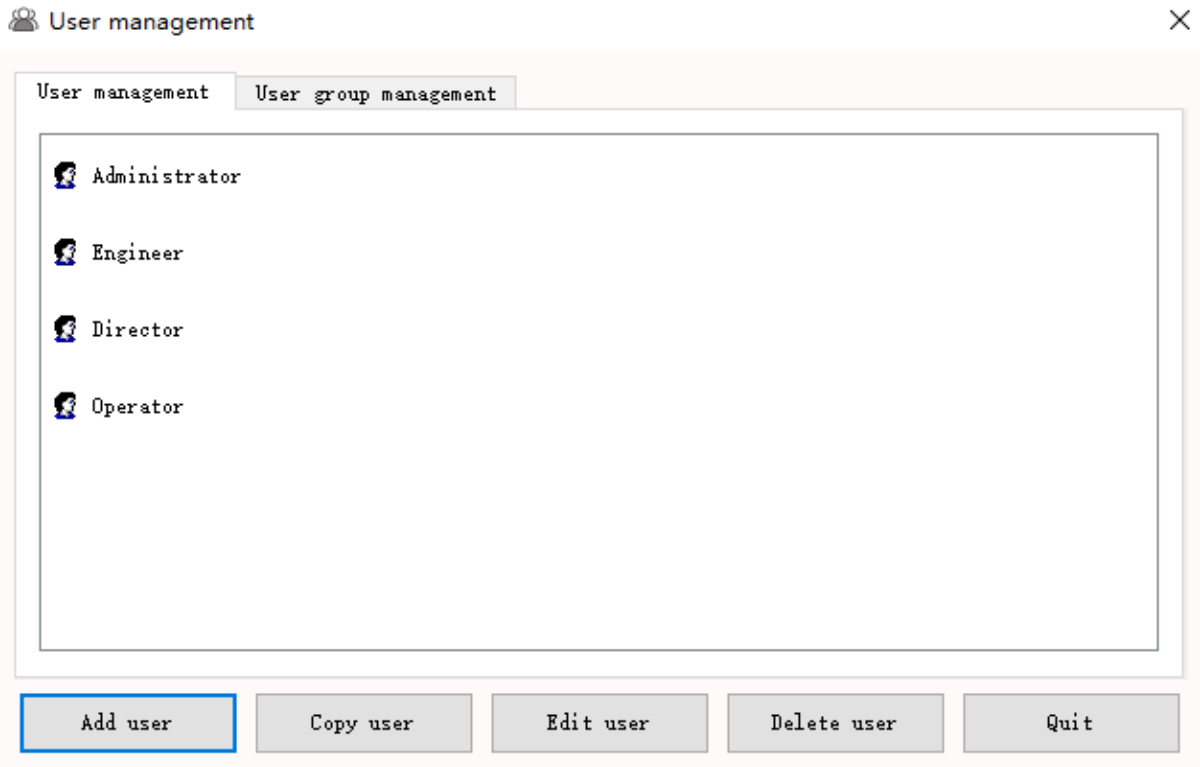

- **Authorized to Change Setpoint/ Everyone Can Change Setpoint:** Touch it to change the authority setting for operators' login.



Display **Authorized to Change Setpoint**

Current setting is everyone can change Setpoint.

Operators not logged in the system can run/stop the system and change the setpoint

Display **Everyone Can Change Setpoint:**

Current setting is authorized to Change the setpoint.

Only the operator's login the system can run/stop the system and change the set value.

- **Max ID:** Max temperature ID scanned by system (1 to 120). Set this parameter based on requirements. System startup time is proportional to this value.
- **With SVG /IO:** When selected, system will scan SVG or I/O module.  
When Max ID number =120, system defaults to scan SVG or I/O module, whether this item is selected or not.

Remarks: (Red  - not checked, green  - checked)

### 5.2.2 Time

For the system time initialization, the setting method is:

- 1) Touch the parameters required to set, then input the value on the screen keyboard.
- 2) Touch the **[OK]** to finish the modification.

**NOTE:** If no response after you Touchs the parameter values, it indicates that this parameter cannot be modified.

### 5.2.3 Cabinet Temperature & ID

Display the current max. cold-junction temperature (Ambient temperature in the cabinet) of all modules, and its zone number.

### 5.2.4 System

- **Data Record Interval:** After setting time, the system will save the data automatically.  
0 min. means not to save the data, and you cannot see the history curve.
- **Auto Pager Time:** After setting time, main interface displays the next page automatically.  
0 sec. means not to auto pager.
- **System Log:** By Touching it, you can check the system operation log.

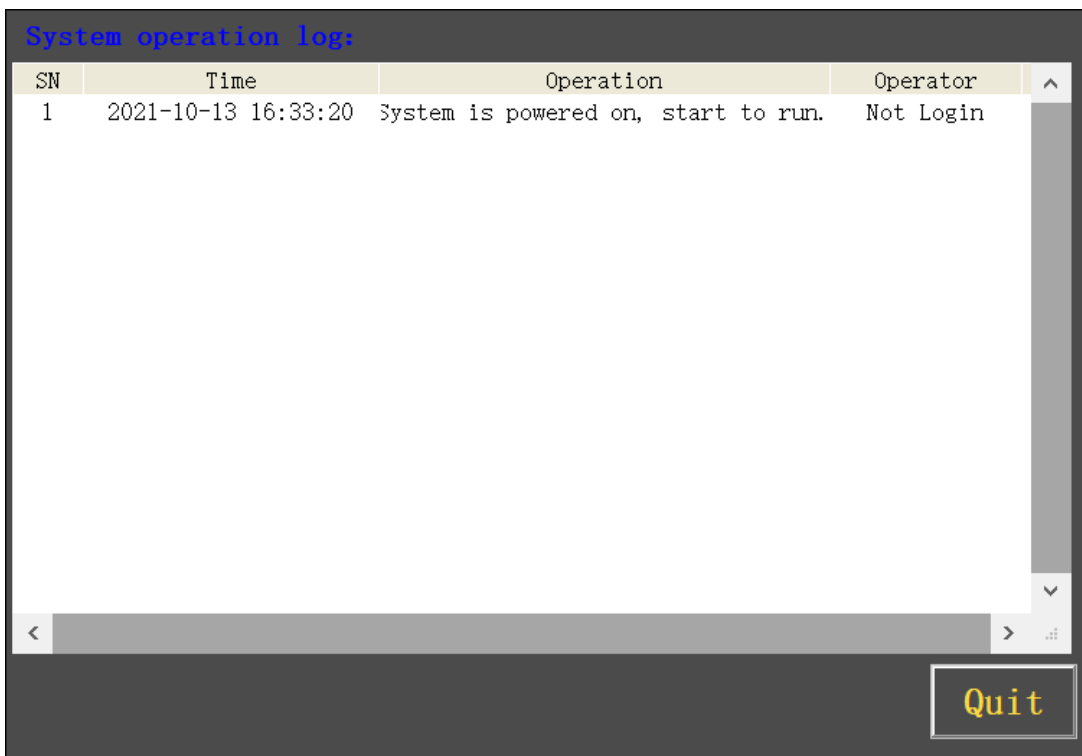

SN	Time	Operation	Operator
1	2021-10-13 16:33:20	System is powered on, start to run.	Not Login

### 5.2.5 Language

- Touch the corresponding language button, to change the system language.
- Remark: After changing language, you need to restart the power switch of HMI (screen).  
Otherwise, some function may not work.

### 5.2.6 Control Modules

Display the communication status of each module and its type.

- **Software version:** View current system software version.

### 5.2.7 Auxiliary Functions

Touch **Aux** , to enter Auxiliary function configuration page.

Remark: (  red = unchecked,  green = checked )

<b>Aux-Function:</b> Ua ID: <input style="width: 50px;" type="text" value="0"/> Ub ID: <input style="width: 50px;" type="text" value="0"/> Uc ID: <input style="width: 50px;" type="text" value="0"/> <input type="radio"/> Over-voltage <input type="radio"/> Remote Stop <input type="radio"/> Remote Standby Standby Delay: <input style="width: 50px;" type="text" value="0"/> Min Standby Time: <input style="width: 50px;" type="text" value="0"/> Min	<b>Alarm Output:</b> <input type="radio"/> T/C Broken <input type="radio"/> T/C Error <input type="radio"/> Load Shorted <input type="radio"/> Over Temp <input type="radio"/> Under Temp <input type="radio"/> Load Broken <input type="radio"/> T/C Reversed	<input type="radio"/> Leakage <input type="radio"/> Triac <input type="radio"/> Over Current <input type="radio"/> Fuse Blown <input type="radio"/> No Response <input type="radio"/> Over voltage <input type="radio"/> CC Over Temp <input type="radio"/> CC Comm Failed	<b>Other:</b> <input type="radio"/> Save Status <input type="radio"/> Text Button <input type="radio"/> OAID Monitor <input type="radio"/> Resolution:0.1 <input type="radio"/> Pro <input type="radio"/> Uniform Temp Control
<b>Communication Protocol:</b> <input checked="" type="radio"/> Disable <input type="radio"/> MODBUS-TCP/IP <input type="radio"/> MQTT <input type="radio"/> OPC-UA	<b>Temp-OK Tolerance:</b> <input style="width: 50px;" type="text" value="0"/> <input type="radio"/> Output Signal	<b>SVG pro:</b> <input type="radio"/> SVG Time Display:	<input type="button" value="Mold test"/> <input type="button" value="Quit"/>

- **A/B/C Phase Voltage ID**

Module's power voltage will be displayed in status bar on main interface.

- **Over Voltage halt**

When power supply over voltage, alarm is triggered, and the system will stop running.

- **Remote Stop control**

When the system receives external stop signal, it will stop running.

- **Remote Standby Delay& Standby Time:**

Once injection signal stop, system start countdown (standby delay time). Once countdown ends, controller will turn to standby mode if no new injection signal. It will keep working in standby mode until delay time ends, or AUTO button is pressed on HMI.

- **Alarm Output Setting**

For 15 common faults (T/C Broken, Load Shorted, Over Temp, over voltage, etc.), customers can choose to connect some or all of the faults to an external alarm output device. When the selected fault occurs, the system will give a relay output signal to drive the external devices work.

- **Other Parameters**

- ◆ **Save Status:** Zones' work state will be the same as before when re-start the system.
- ◆ **Text Button:** Function button be shown in **character** instead of ICON.
- ◆ **OAID Monitor:** Zone's original ID and original valve gate value is displayed, used for maintenance.
- ◆ **Resolution 0.1:** Present temperature's display resolution is 0.1.
- ◆ **Pro:** This can enter to simple working mode (refer to Chapter 6.8)
- ◆ **Uniform Temp Control:** Synchronous heating can be selected when starting system or selected temperature zone to reduce temperature difference.

Remark: (  red = unchecked,  green = checked )

- **Communication Protocol**

Three communication protocols can be selected, MODBUS-TCP/IP, MQTT, OPC-UA. It can remotely read system working status and working parameters, support remote start/stop system and single-segment start and stop, and support remote modification of temperature setting value.

- **Temp-OK Tolerance:**

When the temperature of all zones are within the maximum tolerance range of the setting value (target temperature  $\pm$  maximum tolerance value), the normal output contact is closed.

- **SVG Pro:**

When the button is checked, the SVG time display starts working. Once system receives injection input signal, setting value of T1/T2/T3/T4 will work from static to dynamic mode by countdown.

For example, when the setting value of T1 turn to zero, T2 starts countdown. And so on.

### • Mold Self-inspection

You can do self-inspection on multiple heating zones of the mold one by one before working. Set the start ID and end ID (maximum 100) to determine the scope of the test. Set the maximum working temperature to limit the temperature rise and prevent accidents. After test, 10 kinds of faults can be predicted (such as heater broken, heater shorted, sensor reverse connection, T/C broken, etc.) to warn the user. Please contact the manufacturer for more information.

ID	Watt	Heat ID	SensorID	Status	Fault	Start ID
1	NO	1	0	NO	NO	1
2	NO	2	0	NO	NO	
3	NO	3	0	NO	NO	
4	NO	4	0	NO	NO	
5	NO	5	0	NO	NO	End ID
6	NO	6	0	NO	NO	20
7	NO	7	0	NO	NO	
8	NO	8	0	NO	NO	
9	NO	9	0	NO	NO	
10	NO	10	0	NO	NO	Maximum operating temperature
11	NO	11	0	NO	NO	0
12	NO	12	0	NO	NO	
13	NO	13	0	NO	NO	
14	NO	14	0	NO	NO	Run
15	NO	15	0	NO	NO	
16	NO	16	0	NO	NO	
17	NO	17	0	NO	NO	
18	NO	18	0	NO	NO	
19	NO	19	0	NO	NO	
20	NO	20	0	NO	NO	

when not in voltage regulation mode
Die self check stop.
2021/10/13 16:43:31

### 5.2.8 42-zone / 24-zone Display Shifting

Touch **42P** **24P** , , you can switch 24 zone and 42 zone display in one page.

### 5.2.9 Clear Operation Log & Historical Data

Touch  **[Clear]**, you can clear all operation log and historical curve data. **(Caution!)**

### 5.2.10 Sensor Fault Solution

In case of sensor failure, you can appoint a zone as another zone's reference to allow you to finish the production run. Typically, the sensors of these two zones are near and of the same watt as each other, such as 2 similar hot runner nozzles.

When the sensor of the zone (Fault ID) fails the controller will use the temperature of the other zone ( Related ID) to stimulate the fault one.

This function can be enabled or disabled according to requirements.

- 1) Touch the **[Sensor Fault Solution]** to enter to setting interface.
- 2) Set Fault ID and Related ID. You can set 12 groups at most.
- 3) Touch the **[Enable]** or **[Disable]** to open or stop this function.

Remark: (  red = unchecked,  green = checked )

- 4) Touch **[Quit]**, exit this interface.

**Sensor Fault Solution:**

No.1 Fault ID: <input type="text" value="0"/> Related ID: <input type="text" value="0"/>	No.2 Fault ID: <input type="text" value="0"/> Related ID: <input type="text" value="0"/>	No.3 Fault ID: <input type="text" value="0"/> Related ID: <input type="text" value="0"/>	No.4 Fault ID: <input type="text" value="0"/> Related ID: <input type="text" value="0"/>
No.5 Fault ID: <input type="text" value="0"/> Related ID: <input type="text" value="0"/>	No.6 Fault ID: <input type="text" value="0"/> Related ID: <input type="text" value="0"/>	No.7 Fault ID: <input type="text" value="0"/> Related ID: <input type="text" value="0"/>	No.8 Fault ID: <input type="text" value="0"/> Related ID: <input type="text" value="0"/>
No.9 Fault ID: <input type="text" value="0"/> Related ID: <input type="text" value="0"/>	No.10 Fault ID: <input type="text" value="0"/> Related ID: <input type="text" value="0"/>	No.11 Fault ID: <input type="text" value="0"/> Related ID: <input type="text" value="0"/>	No.12 Fault ID: <input type="text" value="0"/> Related ID: <input type="text" value="0"/>

**Enable**     
  **Automatic Manual Control**     
 Sampling tolerance:  $\pm$       
 **Quit**

#### • Auto-Manual Mode Shifting

When this function is selected, the system will automatically switch to manual control mode once the sensor is damaged. System will take the steady-state output value before disconnection as the initial value of the manual output.

**Target sampling error range:** for example, when SV= 200°C, the error range value is set to  $\pm 5$ , then the actual measured temperature (PV) is between 195–205°C. In this way, the output can be called steady-state output, and it can be used as the initial value of the manual output value.

### 5.2.11 Speed Related Setting

You can divide all zones into 2 to 4 groups (max.11 zones in each group, the zones not appointed will be the last group). The groups will start to work one by one in turn.

When the system starts, the first group will work. When each zone's temperature arrives at the target value (the tolerance can be set), the second group will work. Then the third and the fourth group in turn.

Typically, the slower heating manifolds should be in the first group and the faster heating nozzles are set in the last group.

This function can be enabled or disabled according to the requirements.

- 1) Touch the **[Speed Related Setting]** to enter its setting interface.

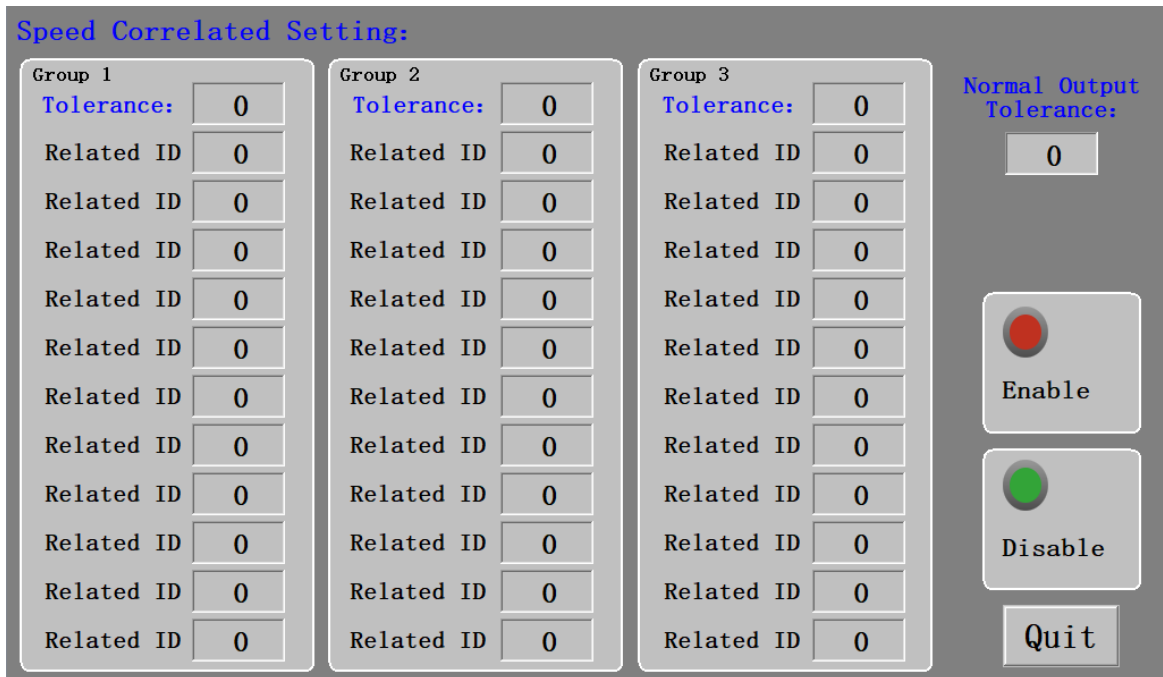

- 2) Appoint zones for each group.

If you need to divide all zones into 2 groups, you can only appoint zones for group 1, the remaining zones will be the second group.

- 3) Set the target tolerance for each group.

If you need the next group to work when each zone's temperature is 5°C (°F) lower than its target , then you should set the tolerance to 5 for this group.

- 4) Touch the **[Enable]** or **[Disable]** to start or stop this function.

(  red - unchecked,  green - checked)

- 5) Touch **[Quit]**, closing this interface.

### 5.2.12 Help

Touch  **[Help]**, to get the helps on the operation.

### 5.2.13 Back

Touch  **[Exit]**, to go back to the main interface.



## Chapter 6 Temperature Control Operations

### 6.1 Control Modes

#### [Auto]:

This type of control is a “closed loop” system and requires a thermocouple feedback signal.

The controller uses a PID algorithm to determine the required output power to hold the actual temperature value equal to the set value.

This mode is applied on all zones when the system starts to work.

#### [Standby]:

This type of control is similar to Auto mode. It is a “closed loop” system and requires a thermocouple feedback signal.

The controller uses a PID algorithm to determine the required output power to hold the actual temperature value equal to standby temperature value (70% of set value).

#### [Manual]:

This type of control is an “open loop” system and requires no thermocouple feedback signal.

The controller regulates output power according to the manual setting.

This mode only can be selected by zone setting.

#### **Auto Tune function:**

This function is for getting the optimal PID value in some system.

It is a “closed loop” system and requires a thermocouple feedback signal.

Typically, AT function only needs to be executed when PID factory setting cannot meet the system requirements.

After finished auto tuning, the optimal PID value would be saved, and the controller returns to Auto mode.

This function only can be selected by zone setting.

*Notes: To start PID auto-tuning function, present temperature value should be lower than set value.*

### 6.2 Soft Start (dehumidify) Function

To avoid humidity making the heater burn out prematurely, the soft start function heats the system slowly to remove excess moisture from the heater.

Temperature controller	CTI Series
------------------------	------------

During soft start, the output power step up from 0% until the temperature rises to 100°C (212°F) and holds it. When soft start time is over, the controller will return to normal work mode.

**Soft start condition:**

- a) The soft start function is on (parameter Soft Start =1~10).
- b) The process temperature is less than 100°C (212°F).

### 6.3 Detail Parameters for Each Zone

Parameter	Description
<b>Setpoint</b>	Target temperature value, full scale
<b>Alarm High</b>	High deviation alarm value. When actual value > Setpoint + Alarm High, zone alarms and shut off output.
<b>Alarm Low</b>	Low deviation alarm value. When actual value < Setpoint + Alarm Low, zone alarms.
<b>Sensor Type</b>	J - J type thermocouple;      K - K type thermocouple;
<b>Temp Unit</b>	Temperature unit: °C or °F
<b>Soft Start</b>	0 - Off.      1~10: On, soft start time = (1~10) ×80s
<b>Control Cycle</b>	0 - Phase control.      1~10 - Zero-cross control, cycle = 1~10s
<b>Self-adaption</b>	Controller studies the system and use the optimized PID value to control output. 0 - Off.      1 - On.
<b>P</b>	Control proportional band, 1 to span.
<b>I</b>	Integral time, 1~999s.
<b>D</b>	Differential time, 1~999s.
<b>T/C Offset</b>	Sensor correction is made by adding it to measured value.
<b>CC Max Temp</b>	Temperature of control card in the mainframe high alarm value, unit is same as parameter C/F setting. 0 - Off.
<b>Max Output</b>	High limit of output power percent, 0~99%. 0 - Off.
<b>Rated Current</b>	Rated load current (Amps). Alarms when the actual load current is over the setting value.



<b>Heater Life (%)</b>	_____ W (the remaining life of the heater) System calculates automatically, cannot be set by manual
<b>Setpoint Min</b>	The target temperature value cannot be less than the lower limit
<b>Setpoint Max</b>	The target temperature value cannot exceed the upper limit value

## 6.4 Zone Setting

Touch the upper part of each zone, you can enter zone's parameters setting interface.  
Remark: different users can see different parameters.

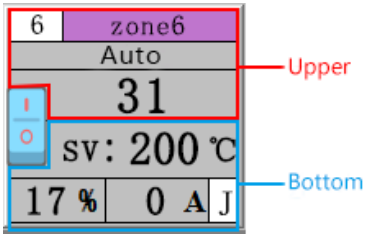

### 6.4.1 Operator Login Status



- **Change Set Value:** Touch [<<] [^] [v]
- **Save Set Value:** Touch [SET]
- **Run or Stop this zone:** Touch [Run] / [Stop]

### 6.4.2 Engineer Login Status

- **Change Set value:** Touch it to call up small keyboard.
- **Run or Stop this zone:** Touch [Run]/[Stop].
- **Change Control mode of this zone:**  
Touch [Auto] or [Manual], then confirm it.
- **Set power output percent in Manual mode:**  
Touch it to call up small keyboard.
- **Back to main interface:** Touch [Quit]

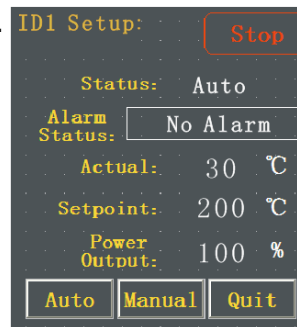

### 6.4.3 Director / Administrator Login Status

Parameters Setting: Alarm No Alarm

<p><b>Current Status:</b></p> <p>ID Name: zone16</p> <p>Actual: 32 °C</p> <p>Output: 100 %</p> <p>Manual: 100</p> <p>CC Temp: 32 °C</p> <p>Status: Auto</p>	<p><b>Advanced Parameters:</b></p> <table border="1" style="width: 100%; border-collapse: collapse;"> <tr><td>SensorType</td><td>J (J/K)</td><td>Max Output</td><td>0</td></tr> <tr><td>Temp Unit</td><td>°C (°C/°F)</td><td>Rated Current</td><td>15</td></tr> <tr><td>Soft Start</td><td>2</td><td>T/C Error Detection</td><td>0</td></tr> <tr><td>Control Cycle</td><td>1</td><td>Load Check</td><td>4</td></tr> <tr><td>Self-adaption</td><td>0</td><td>Max. Current</td><td>18</td></tr> <tr><td>P</td><td>42</td><td>Filter</td><td>5</td></tr> <tr><td>I</td><td>100</td><td>Load-short Detection</td><td>0</td></tr> <tr><td>D</td><td>20</td><td>Slow Heating</td><td>N (Y/N)</td></tr> <tr><td>T/C Offset</td><td>0</td><td>No Response</td><td>0</td></tr> <tr><td>CC Max Temp</td><td>0</td><td>Over-Voltage</td><td>14</td></tr> </table>	SensorType	J (J/K)	Max Output	0	Temp Unit	°C (°C/°F)	Rated Current	15	Soft Start	2	T/C Error Detection	0	Control Cycle	1	Load Check	4	Self-adaption	0	Max. Current	18	P	42	Filter	5	I	100	Load-short Detection	0	D	20	Slow Heating	N (Y/N)	T/C Offset	0	No Response	0	CC Max Temp	0	Over-Voltage	14
SensorType	J (J/K)	Max Output	0																																						
Temp Unit	°C (°C/°F)	Rated Current	15																																						
Soft Start	2	T/C Error Detection	0																																						
Control Cycle	1	Load Check	4																																						
Self-adaption	0	Max. Current	18																																						
P	42	Filter	5																																						
I	100	Load-short Detection	0																																						
D	20	Slow Heating	N (Y/N)																																						
T/C Offset	0	No Response	0																																						
CC Max Temp	0	Over-Voltage	14																																						

<p><b>General Parameters:</b></p> <p>Setpoint: 200</p> <p>Alarm High: 30</p> <p>Alarm Low: -30</p>	
--	--







OFF  
  
  
Auto Tune

Zone's Setting & Status: Alarm: No Alarm

<p><b>Current Status:</b></p> <p>ID Name: zone16</p> <p>Actual: 32 °C</p> <p>Output: 100 %</p> <p>Manual: 100</p> <p>CC Temp: 32 °C</p> <p>Status: Auto</p>	<p><b>Advanced Parameters:</b></p> <table border="1" style="width: 100%; border-collapse: collapse;"> <tr><td>Normal Power (%)</td><td>0</td></tr> <tr><td>Power Deviation (%)</td><td>0</td></tr> <tr><td>Load rated power</td><td>0 W</td></tr> <tr><td>Actual Power</td><td>0 W</td></tr> <tr><td>Heater life (%)</td><td>100 %</td></tr> <tr><td>Setpoint Min</td><td>0</td></tr> <tr><td>Setpoint Max</td><td>0</td></tr> </table>	Normal Power (%)	0	Power Deviation (%)	0	Load rated power	0 W	Actual Power	0 W	Heater life (%)	100 %	Setpoint Min	0	Setpoint Max	0
Normal Power (%)	0														
Power Deviation (%)	0														
Load rated power	0 W														
Actual Power	0 W														
Heater life (%)	100 %														
Setpoint Min	0														
Setpoint Max	0														

<p><b>General Parameters:</b></p> <p>Setpoint: 200</p> <p>Alarm High: 30</p> <p>Alarm Low: -30</p>	
--	--

OFF  
  
  
Auto Tune

- **Change ID Name:** Touch it to call up small keyboard and rename the zone you want.
- **Set output power percent in Manual mode:** Touch **Manual** to call up small keyboard.
- **Change General parameters:**  
Touch Setpoint to call up small keyboard.  
Touch Alarm High to call up small keyboard.  
Touch Alarm Low to call up small keyboard.
- **Run or Stop this zone:** Touch  **[Run]** /  **[Stop]**
- **Turn off or turn on this zone:** Touch **[OFF]** / **[ON]**
- **Switch to Manual mode** (in running state): Touch  **[Manual]**.
- **Activate Boost function** (fast heating speed): Touch  **[Boost]**, and the power output percent will be added 20% (max.100%) for 15s.
- **Start Auto-Tune this zone:** Touch. 
- **Select background color for this zone:** Touch  **[Color]**
- **Back to main interface:** Touch  **[Exit]**

## 6.5 Group Config & Tools

Touch  [Group] on the main interface, enter to the Group Configuration & Tools Management.

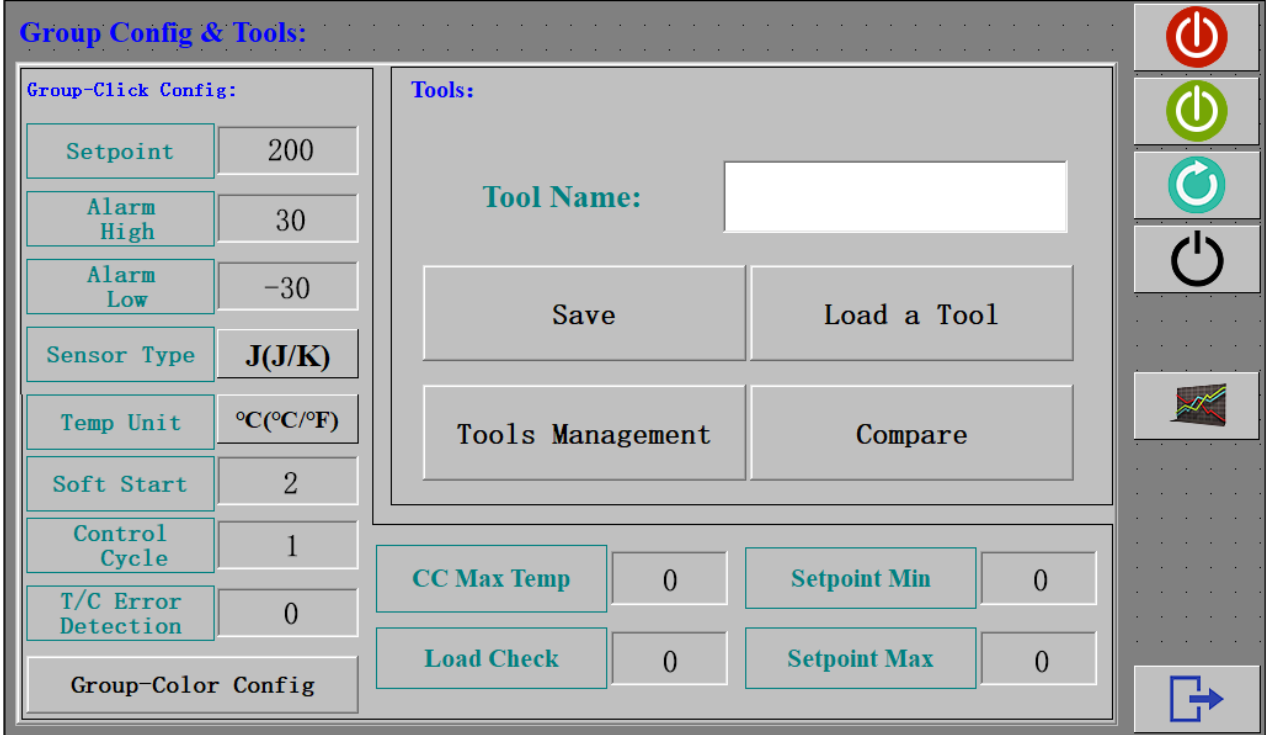

**Group Config & Tools:**

**Group-Click Config:**

Setpoint	200
Alarm High	30
Alarm Low	-30
Sensor Type	J(J/K)
Temp Unit	°C(°C/°F)
Soft Start	2
Control Cycle	1
T/C Error Detection	0

**Tools:**

Tool Name:

Save      Load a Tool

Tools Management      Compare

CC Max Temp      0      Setpoint Min      0

Load Check      0      Setpoint Max      0

Group-Color Config



[Graph]: Check Present Curve and History Curve. (see Chapter 6.6)

### 6.5.1 Group Setting

Parameters for zones with the same background color can be set all together.

#### 6.5.1.1 Group Configuration Setting

Used to set parameters for all zones.

- 1) Touch Setpoint to call up small keyboard.
- 2) Input the required value.
- 3) Touch [OK] to complete the setting.

**NOTE:** If there is no response when you Touch the parameter's value, it means you don't have the authority in current user.

#### 6.5.1.2 Group Color Setting

Used to set parameters for zones with the same background color and run or stop these zones.

**Comment:** To set the background color of each zone, please refer to 6.4.3

- 1) Touch [Group-Color Config], background color selected window will appear.
- 2) Select the background color of zones you want, the setting page will appear.

On this page, [Run] / [Stop] button only works for these zones.

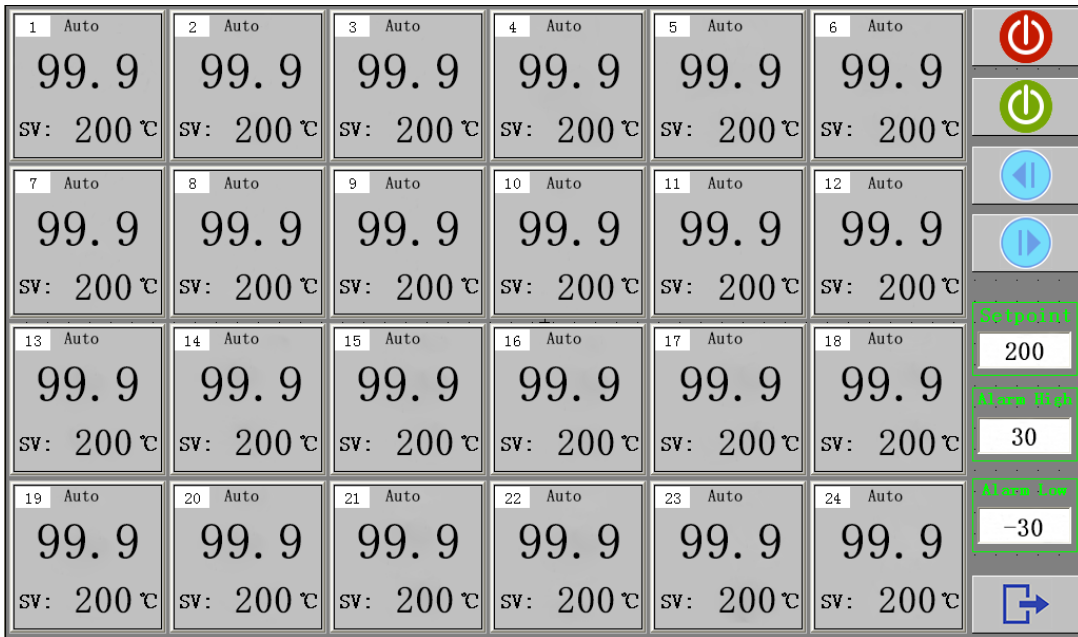

- 3) Touch [Setpoint] or [Alarm High] or [Alarm Low] to call up small keyboard.
- 4) Input the required value.
- 5) Touch [OK] to complete the setting.

**NOTE:** If there is no response when you touch the parameter's value, it means the parameter cannot be changed or the authority is not enough.

## 6.5.2 Tools Management

You can manage the mold patterns by **Tools Management**.

CTI can save a maximum 72 sets of mold files to the local memory, as well as to USB disk.

You can import, export, and delete the mold files, etc.

**NOTE:** The mold pattern file is a database file containing the parameters of each zone.

### 6.5.2.1 New pattern's Config Export

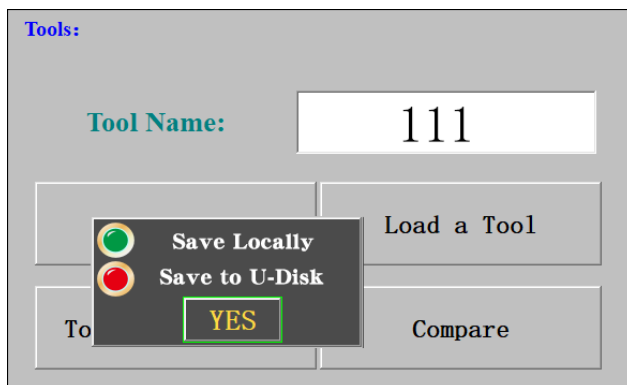



1. Input a new pattern name in the box.
2. Touch the **[Save]** to save the name of the new pattern name.  
Zones' On/Off state, auto/manual control mode, and the background color will be also saved in the pattern file.
3. Choose to Save Locally or Save to USB Disk.

**NAME PATTERN CAREFULLY!**

If the name of the new pattern is same as the existing pattern name, the original file will be over-written by the new one.

**6.5.2.2 Load a Tool**

1. Touch the **[Load a Tool]** to enter to the tool name selected interface.

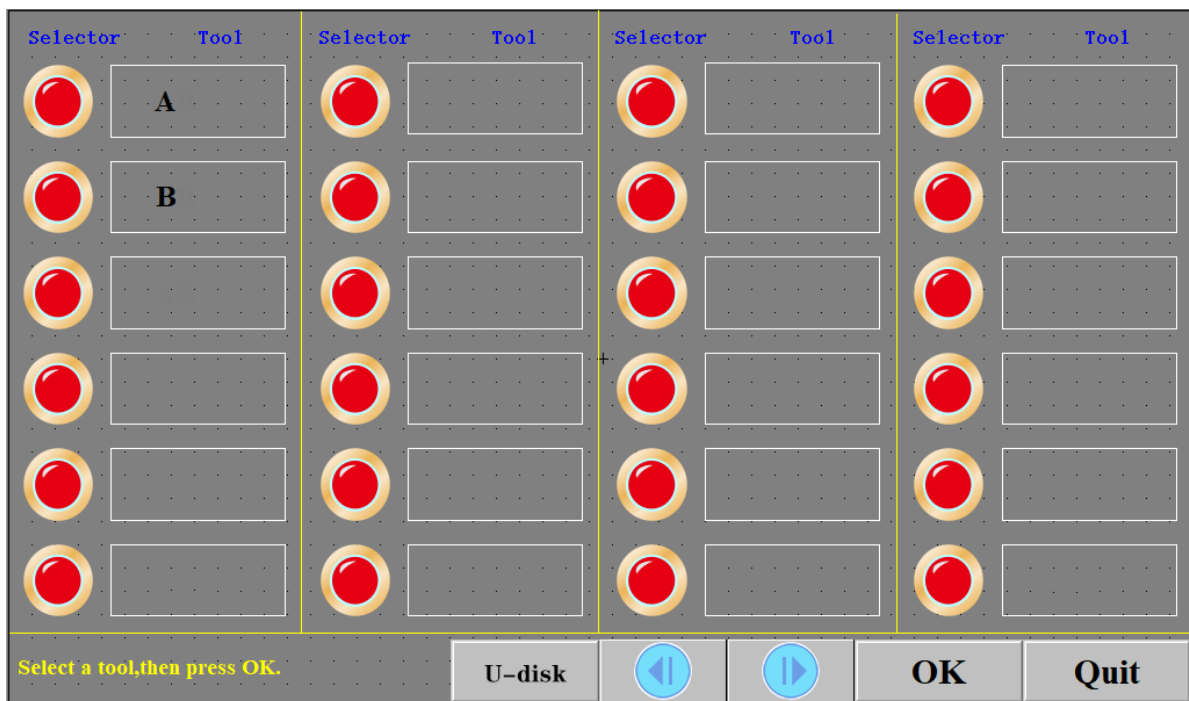



2. Select one tool file needed to use, Touch selector, means selected.
3. Touch **[OK]** to import the parameters in the tool file.  
Confirm to load the tool. Touch **[YES]**.  
The system will generate a tool loaded report in the end of importing process.
4. Touch **[QUIT]** on the report page to close it.
5. Touch **[QUIT]** to back the Group Config & Tools interface.  
All zones will work on new imported settings, and the pattern name will be showed in the status bar.

**6.5.2.3 Tools Management**

Touch the **[Tools Management]** to enter to the management interface.

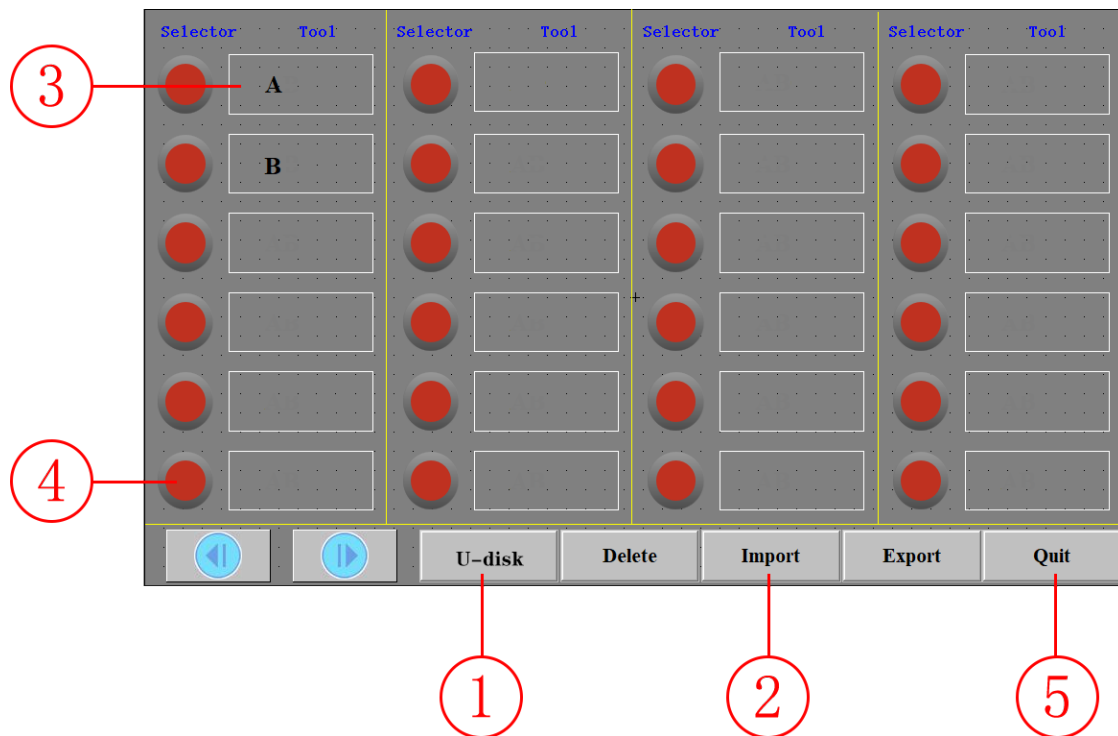
You can browse the tool files in USB disk or locally, and manage these files.



- Files location selected: **[Local File]** or **[USB File]**.
- **[Delete]**: used to delete the selected file.
- **[Import]**: used to import the files selected from the USB disk to the local.
- **[Export]**: used to export the files selected from the local to the USB disk.
- Tool Name.
- Tool selector & indicator:
  -  Red- unchecked,  Green - checked.
- **[Quit]**: back to the Global Config & Tool Management interface.

#### 6.5.2.4 Comparison of Assigned Parameters

1. Input the Tool Name that needs to be compared in the tool files.
2. Touch the **[Compare]** to compare the parameters of the online modules with the ones of the existing tool file.
3. If data is consistent, Touch **[YES]**.

#### 6.5.2.5 Online Browsing and Modify Tool Data

You can browse the ID number and all parameters of each zone. When you Touch a parameter, the parameter changes to yellow filled background (other parameters in the same zone change to blue background). Touch the parameter again to bring up small keyboard to modify it.

Num	Name	SV	ALH	ALL	Sn	C/F	Set	T	Pi	P	I	D
0	ID1	200.000	30.000	-30.000	0.000	0.000	2.000	1.000	5.000	9.000	160.000	20.000
1	ID2	200.000	30.000	-30.000	0.000	0.000	2.000	1.000	5.000	9.000	160.000	20.000
2	ID3	200.000	30.000	-30.000	0.000	0.000	2.000	1.000	5.000	9.000	160.000	20.000
3	ID4	200.000	30.000	-30.000	0.000	0.000	2.000	1.000	5.000	9.000	160.000	20.000
4	ID5	200.000	30.000	-30.000	0.000	0.000	2.000	1.000	5.000	9.000	160.000	20.000
5	ID6	200.000	30.000	-30.000	0.000	0.000	2.000	1.000	5.000	9.000	160.000	20.000
6	ID7	200.000	30.000	-30.000	0.000	0.000	2.000	1.000	5.000	9.000	160.000	20.000
7	ID8	200.000	30.000	-30.000	0.000	0.000	2.000	1.000	5.000	9.000	160.000	20.000
8	ID9	200.000	30.000	-30.000	0.000	0.000	2.000	1.000	5.000	9.000	160.000	20.000
9	ID10	200.000	30.000	-30.000	0.000	0.000	2.000	1.000	5.000	9.000	160.000	20.000
10	ID11	200.000	30.000	-30.000	0.000	0.000	2.000	1.000	5.000	9.000	160.000	20.000
11	ID12	200.000	30.000	-30.000	0.000	0.000	2.000	1.000	5.000	9.000	160.000	20.000
12	ID13	200.000	30.000	-30.000	0.000	0.000	2.000	1.000	5.000	9.000	160.000	20.000
13	ID14	200.000	30.000	-30.000	0.000	0.000	2.000	1.000	5.000	9.000	160.000	20.000
14	ID15	200.000	30.000	-30.000	0.000	0.000	2.000	1.000	5.000	9.000	160.000	20.000
15	ID16	200.000	30.000	-30.000	0.000	0.000	2.000	1.000	5.000	9.000	160.000	20.000
16	ID17	200.000	30.000	-30.000	0.000	0.000	2.000	1.000	5.000	9.000	160.000	20.000
17	ID18	200.000	30.000	-30.000	0.000	0.000	2.000	1.000	5.000	9.000	160.000	20.000

Zone's Setting & Status:
Tool Name: A
Save
Quit

### 6.5.3 Back

Touch **[Exit]**, back to the main interface.

### 6.6 Graph

Touch **[Graph]** on the main interface of **[Group]**, then you can enter to the Real Time Display Screen.

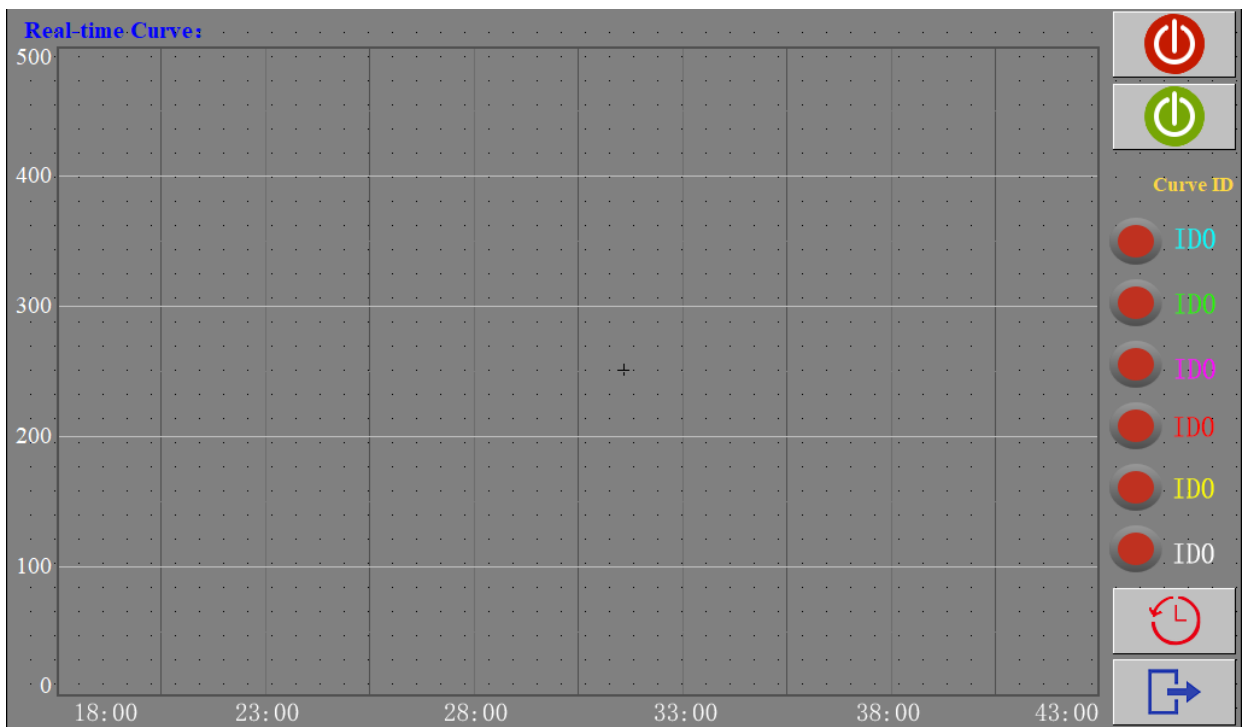

You can select 6 zones max. to view the real-time curve.

Touch  [History] on this screen to enter to the History Curve Display.

Touch  [Exit] back to the main interface.

## 6.6.1 Real-time Curve

### 6.6.1.1 Select Zone ID to View

On Present Curve Screen, you can view max. 6 zones.

- 1) Touch the ID number to enter to curve's ID selection window.
- 2) Input the ID number that you want to view the curve, and then Touch [YES] to confirm.

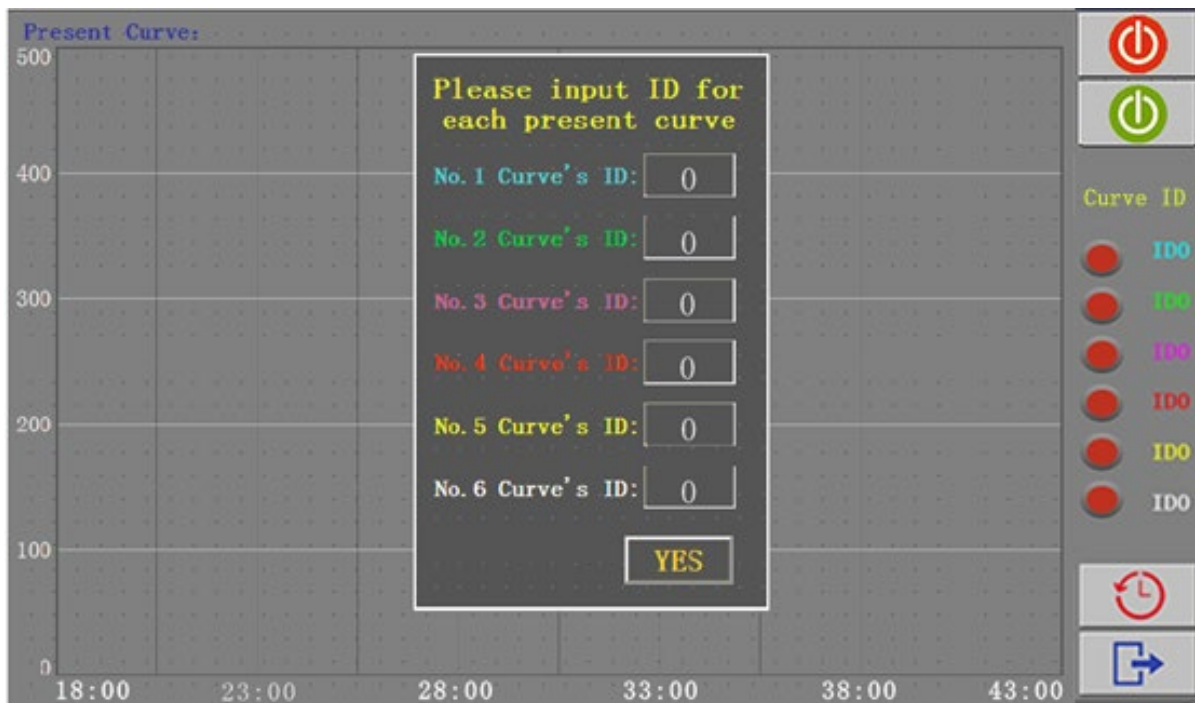

### 6.6.1.2 Select the Curve Display

The round button before the ID number is used to select the curve display.

You can Touch it.  red- unchecked,  green - checked.

The curve's color is same as the color of ID number.

## 6.6.2 History Curve

The system default setting is not saving the temperature data.

If you need to review the history curve or export the history data, you need to set the data save interval in the system setting.

The system can save the temperature data in the latest 15~30 days.

### 6.6.2.1 Select Zone ID to View

We you Touch  **[History]** on present curve screen, History Curve ID selection interface will be displayed.

Each History Curve ID group can display 10 zones.

Select the ID group to view, or back to real time curve by **[Quit]**.

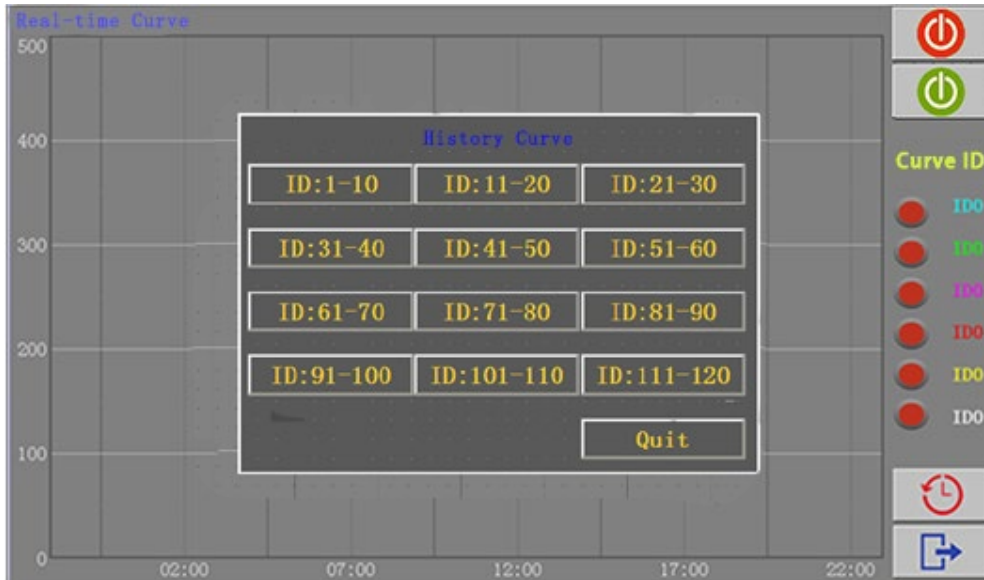

### 6.6.2.2 Select the Curve Display and view temp value.

Touch the round button before the ID number.  red - unchecked,  green - checked.

The curve's color is same as the color of ID number.

Tap any point on the curve with your finger on the history curve, the temperature value of all curves in the same group at that time will be displayed in the content box.

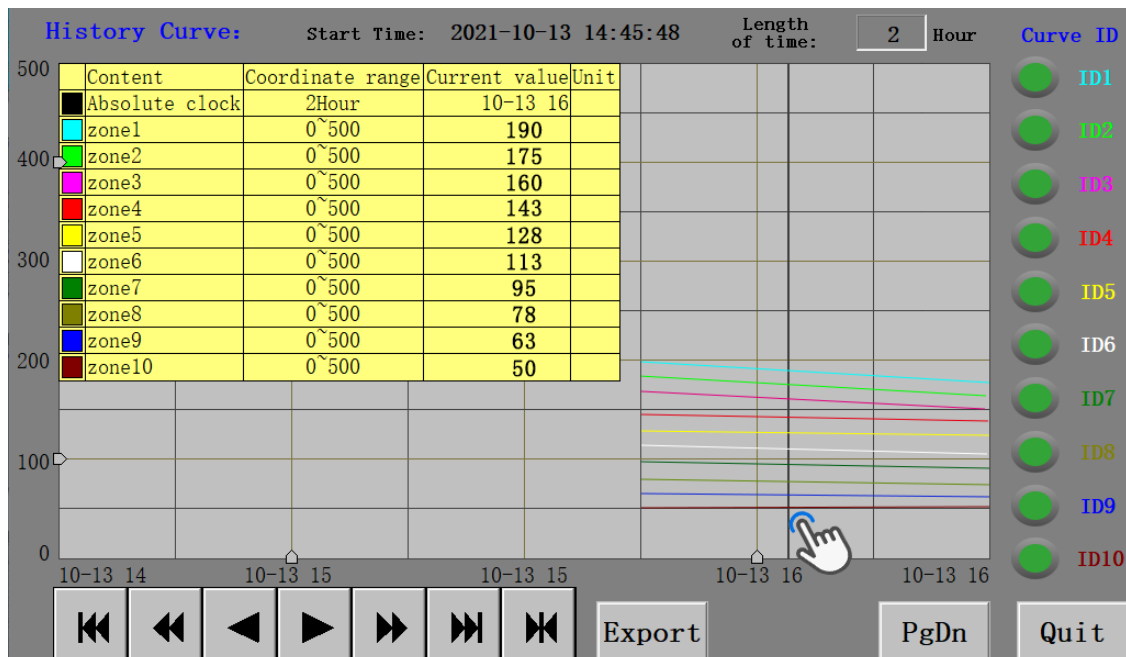

### 6.6.2.3 Select the Curve Start Time





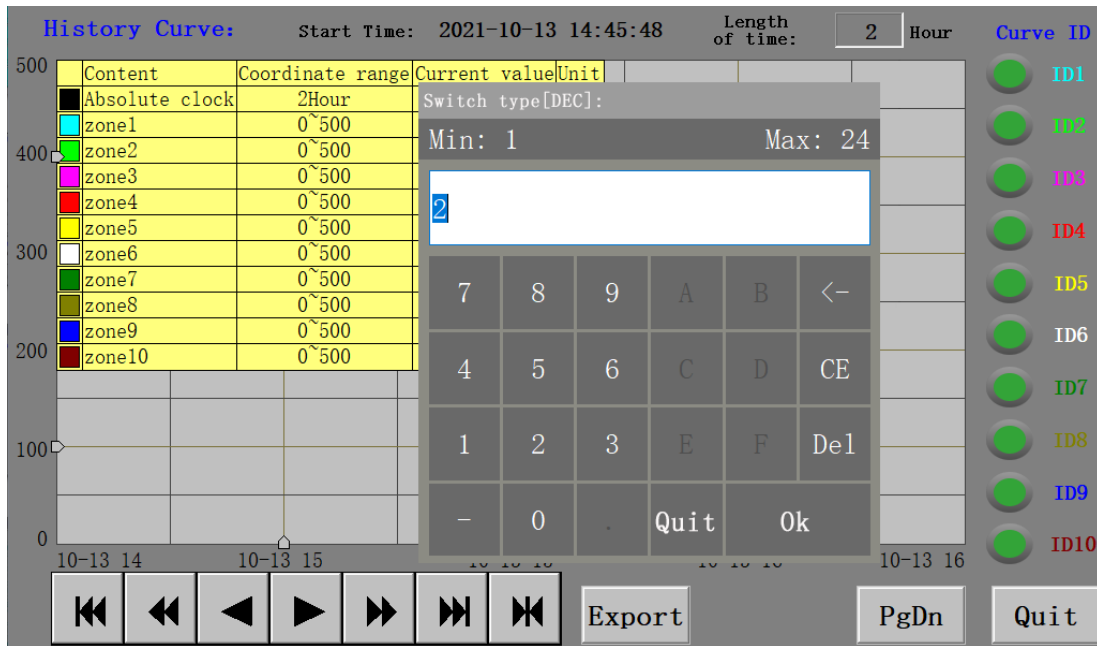

When you enter History Curve interface, the curve start time is 2 hours ago. And display time length of the abscissa (X axis) is 2 hours.

You can Touch on **[length of time]** on top right corner, input a new time value (range 1--24), and the display time range of the abscissa will change to the newly set time length.



You can also select the start time by



- |   |   |   |                                       |
|---|---|---|---------------------------------------|
|  | Forward 0.5 hour based on the curve   |  | Backward 0.5 hour based on the curve. |
|  | Forward 1.0 hour based on the curve   |  | Backward 1.0 hour based on the curve. |
|  | Forward 2.0 hour based on the curve   |  | Backward 2.0 hour based on the curve. |
|  | Select a specified time, or choose a fixed time period, or recent period of time. |   |                                       |

(Refer to the picture below)

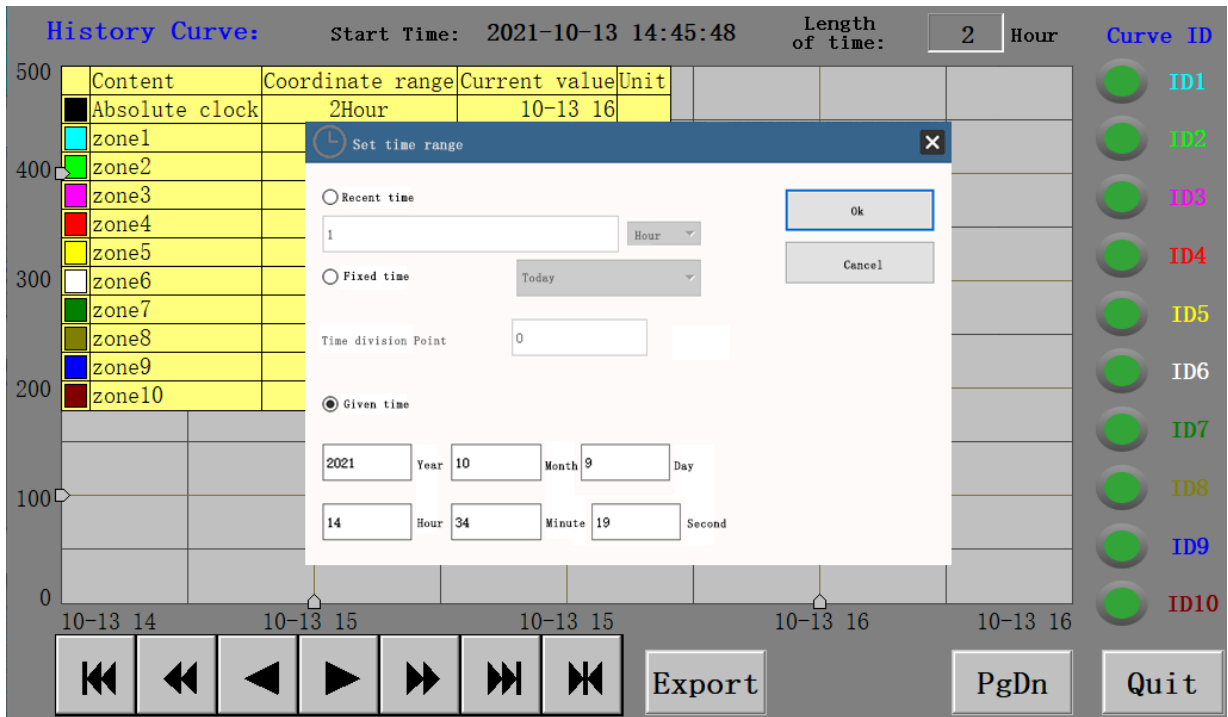

#### 6.6.2.4 Zoom In & Zoom out the Curve.

You can adjust the scale of X/Y axis with the sliding bar, to zoom in or zoom out the curve.

#### 6.6.2.5 View Other Zones

You can view the history curve of other zones by Touching [PgDn] or [PgUp].

In the first page, you will see the [Present] used to back to present curve screen.

#### 6.6.2.6 Export the Historical Data

You can export the historical data record (in csv format) to USB disk by Touching [Export].

##### Notes:

Only support USB disk that use a File Allocation Table (FAT or FAT32) format.

Only support USB versions 2.0 and 1.1.

Use an empty USB disk or one that contain as few files as far as possible.

Do not remove the USB disk from the controller during the writing operation.

#### 6.6.2.7 Back to Present Curve

Touch the [Quit] back to the real-time curve screen.













### 6.7.3 Alarm Status





Alarm Code	Description	Solution
T/C Broken	Thermocouple is broken. Controller will shut off the output.	Check the sensor or switch to manual mode
T/C Reversed	Thermocouple is reversed. Controller will shut off the output.	Check the sensor or switch to manual mode.
T/C Error	Sensor is connected to controller's output terminals. Controller will shut off the output.	Check the wiring. <i>It may cause a false alarm if the heater's power is large.</i>
Over Temp	PV is over high alarm value. Alarm value = Setting value + Alarm High Controller will shut off the output.	Check the controller & the sensor.
Under Temp	PV is under low alarm value. Alarm value = Setting value + Alarm Low	Check the system thermal insulation. Or switch to manual mode.
Load Broken	No heater is detected. Controller will shut off the output.	Check the heater.
Load Shorted	Heater is shorted. Controller will shut off the output.	Check the heater.
Triac	Triac is damaged or out of control. Controller will shut off the output.	Check the triac.
Over Current	Load current is over rated.	Check the heater and the Rated current setting.
Fuse blown	Fuse is blown out.	Check the heater and replace the fuse.
No Response	Heater is working, but temperature does not rise. Controller will adjust output percent to 0.	Check the sensor and its position.
Over Voltage	Supply voltage is over alarm setting.	Check the power supply.
CC Comm Failed	Communication between HMI and control modules is failed	Check the modules and communication wiring.

CC Over Temp	Temperature of control cards in the mainframe is over high alarm value	Check the modules and the fans in the mainframe.
Leakage	Output percent exceeds (Normal Power + Leakage detection) %, the controller will alarm and show "leakage"	Check the mold, clean the leakage.

## 6.8 Simple Working Mode

- Touch  [Settings] on the main interface, Touch , select [Pro].
- Then check it to open the function,  red- unchecked,  green - checked.
- Back to  [Settings], enter to the [Simple Config] Simple Working Mode Setting interface

<b>Stop</b> 	<b>Run</b> 	<b>Standby</b> 	<b>Return</b> 
<b>Working mode</b>	<b>°C(°C/°F)</b>	<b>J(J/K)</b>	
<b>Soft Start</b>	<b>T/C Error Detection</b>	<b>Alarm High</b> <input style="width: 80px; height: 20px;" type="text" value="0"/>	
<b>Power Deviation(%)</b> <input style="width: 80px; height: 20px;" type="text" value="0"/>	<b>Rated Current(A)</b> <input style="width: 80px; height: 20px;" type="text" value="0"/>	<b>Alarm Low</b> <input style="width: 80px; height: 20px;" type="text" value="0"/>	

Touch  to stop all temperature zones of the controller, Touch  to start all temperature zones, Touch  to set all temperature zones to standby mode, Touch  to return to the main interface.

### 6.8.1 Working mode selection.

- Touch [**Working mode**] to enter to working mode selection interface.
- This interface shows the ID of temperature zone/current working mode/setpoint value.
- Touch [**PG+**]/[**PG-**] on the right side to view more temperature zones.
- Touch [**Select All**] to select all temperature zones on all pages.
- Or touch any zones on the screen (the selected zones will be blinking).
- Touch the zones again to cancel the selection.

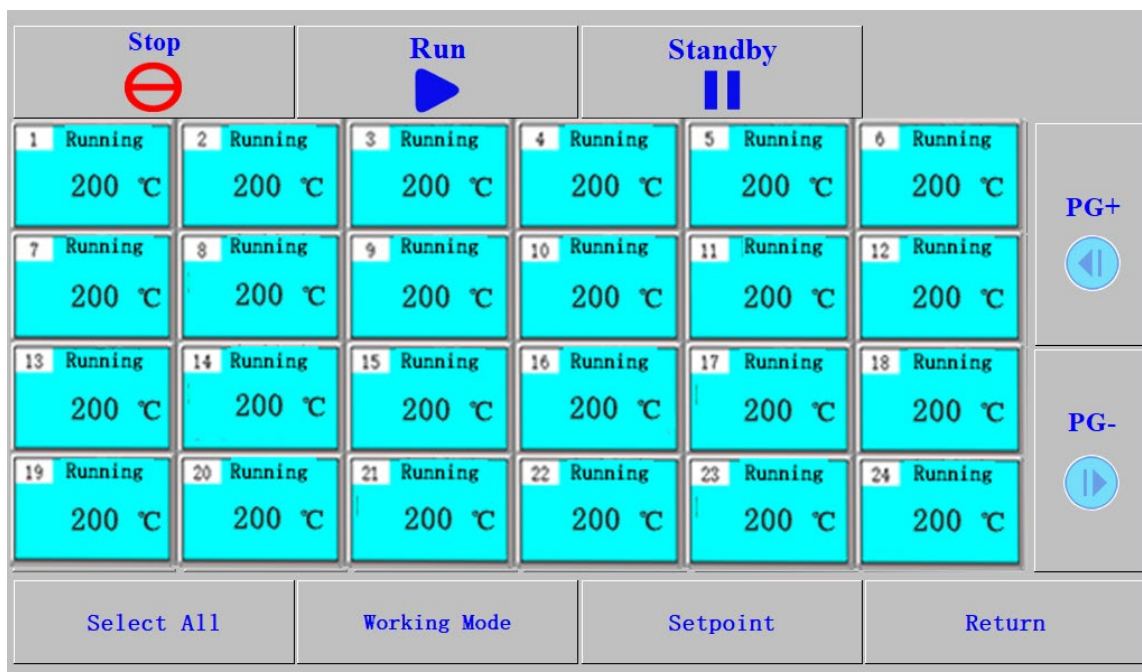

Mark 1: Temperature zone ID number.

Mark 2: Working modes (Stop/Run/Manual /Standby)

Mark 3: Setpoint value (Black in running status, Red in stop status).

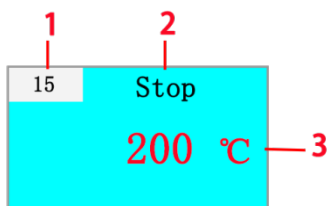

- After running the zones, Touch [**Working mode**] below and in pop-up window you can choose [**Stop/Auto/Manual/Standby**] to switch the working mode.

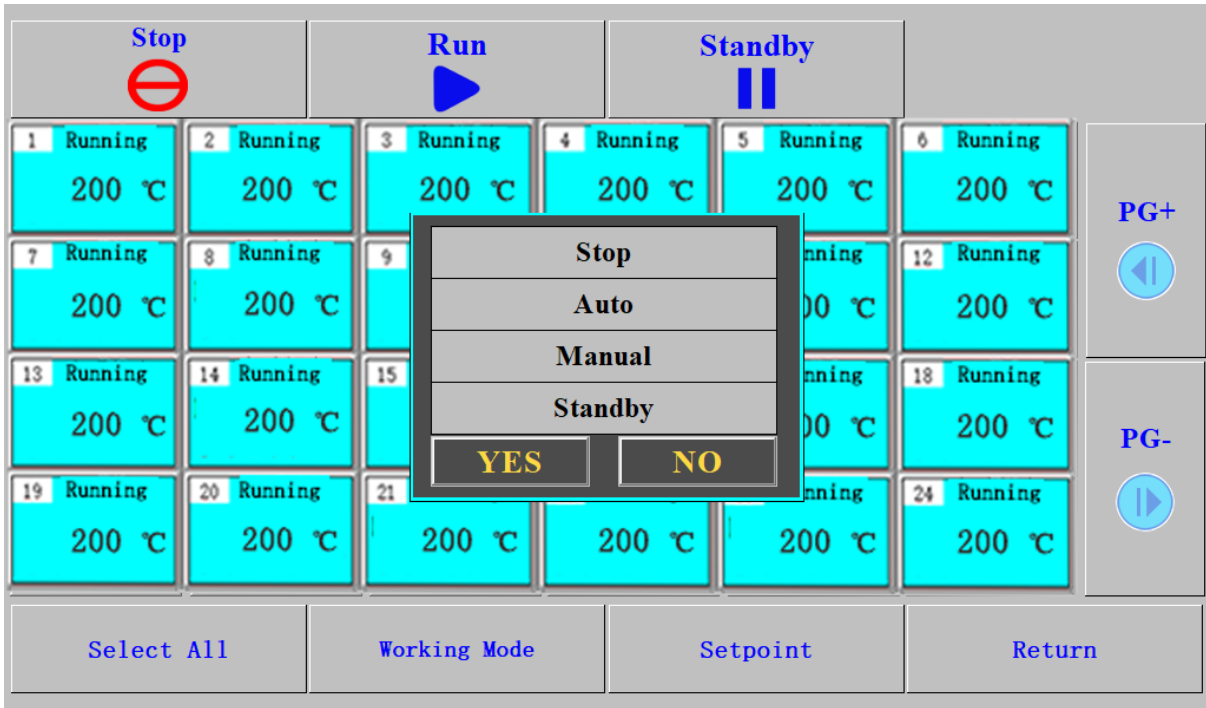

- Touch [**Setpoint**] to modify temperature value in pop-up window.

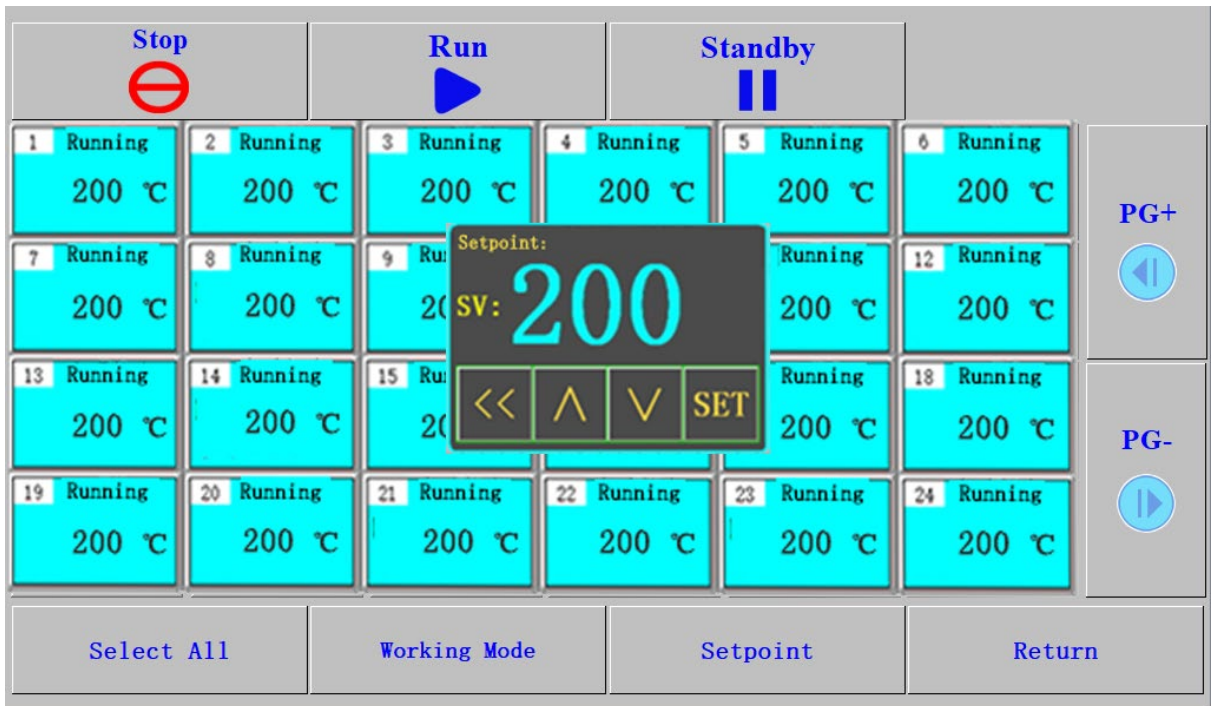

### 6.8.2 Soft Start Setting

- Touch **[Soft Start]** to enter to soft start setting interface.
- Touch **[Select All]** to select all zones or select some zones.
- Touch **[Soft-start Setting]** below and set duration of soft start in pop-up window.
- You can choose **[OFF]** **[2 minutes]** **[5 minutes]** **[10 minutes]**.

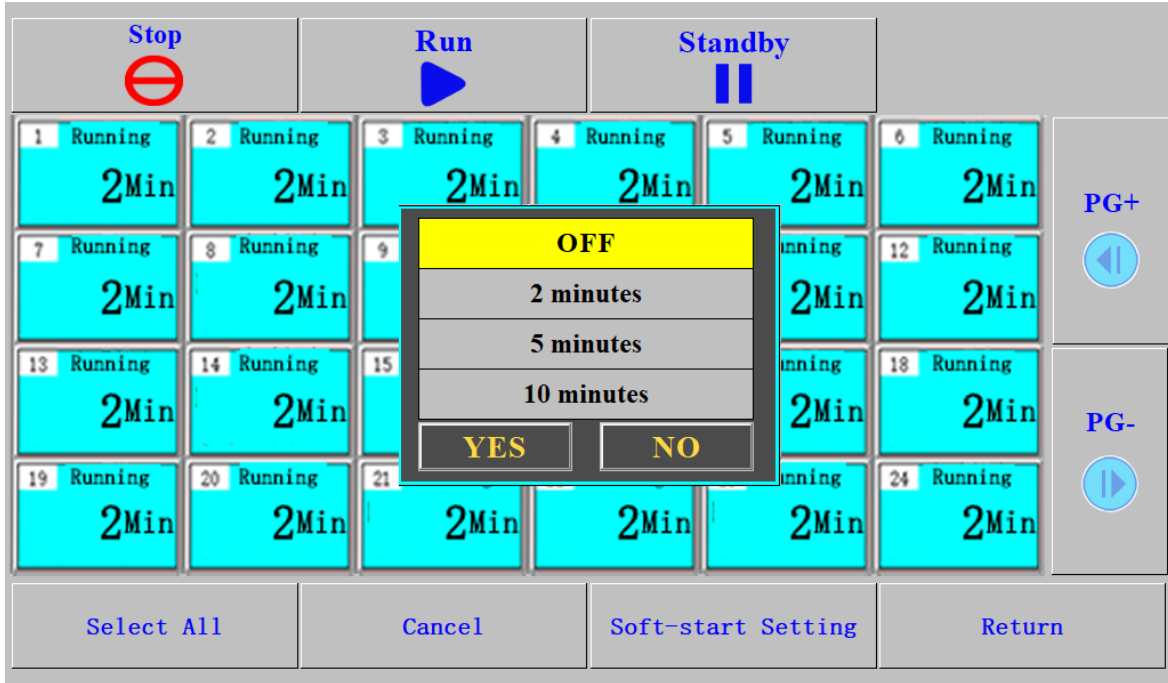

### 6.8.3 Other Parameters Setting

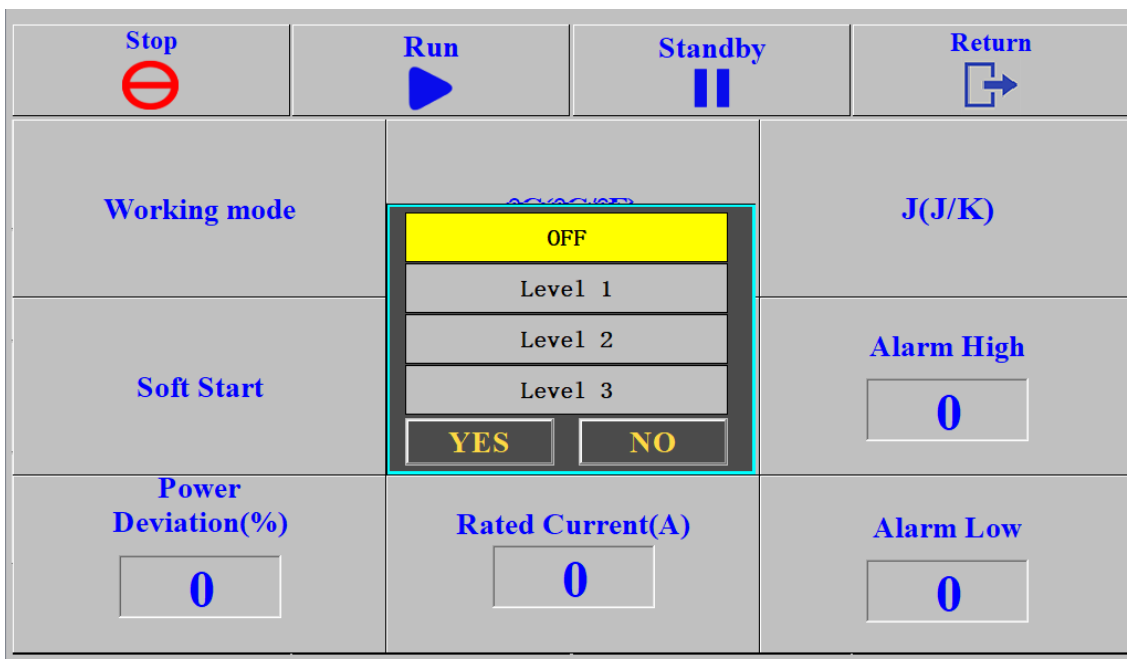

Other parameters can be modified in the working mode setting interface.

**[°C/°F]**: Touch to switch the temperature display unit.

[J/K]: Touch to switch the thermocouple type.

[T/C Error Detection]: Touch to select the sensor fault detection level.

- **OFF: (Sensor no detection)**: Turn off the detection function.
- **Lever 1: (Sensor primary detection)**: Detect the load impedance; when an abnormality is found, it is judged as a wrong connection and an alarm is triggered.
- **Lever 2: (Sensor secondary detection)**: Increase detection of maximum impedance of sensor on the basis of the primary detection.
- **Lever 3: (Sensor three-level detection)**: Increase detection of minimum impedance of sensor on the basis of the secondary detection.

[Alarm High]: Touch value box to set the High deviation alarm value, **Range 0-60**.









[Alarm Low]: Touch value box to set the Low deviation alarm value, **Range -99-0**.

[Power Deviation %]: Touch the value box to set the reference value of the power increase percentage when leakage occurred. When the actual output power increasing percentage exceeds set value, it will be judged as leakage and an alarm will be given. **Range 0-100**.

[Rated current]: Touch value box to set rated load current value. When the actual current value is higher than the set value, an alarm will be given, **Range 1-40**.

## Chapter 7 Sequential Valve Gate Control Operations

Touch  [SVG] on Temperature Control main interface, then you can enter to Sequence Valve Gate Control main interface. Note: page down to the last page of temperature zones.

1	GATE1	Stop	OUT 24V	T1 1.2 s T2 2.2 s T3 3.2 s T4 4.2 s	IN 0	Auto	    <b>Test</b>     
2	GATE2	Stop	OUT 24V	T1 1.2 s T2 2.2 s T3 3.2 s T4 4.2 s	IN 0	Auto	
3	GATE3	Stop	OUT 24V	T1 1.2 s T2 2.2 s T3 3.2 s T4 4.2 s	IN 0	Auto	
4	GATE4	Stop	OUT 24V	T1 1.2 s T2 2.2 s T3 3.2 s T4 4.2 s	IN 0	Auto	
5	GATE5	Stop	OUT 24V	T1 1.2 s T2 2.2 s T3 3.2 s T4 4.2 s	IN 0	Auto	
6	GATE6	Stop	OUT 24V	T1 1.2 s T2 2.2 s T3 3.2 s T4 4.2 s	IN 0	Auto	
7	GATE7	Stop	OUT 24V	T1 1.2 s T2 2.2 s T3 3.2 s T4 4.2 s	IN 0	Auto	
8	GATE8	Stop	OUT 24V	T1 1.2 s T2 2.2 s T3 3.2 s T4 4.2 s	IN 0	Auto	
9	GATE9	Stop	OUT 24V	T1 1.2 s T2 2.2 s T3 3.2 s T4 4.2 s	IN 0	Auto	
10	GATE10	Stop	OUT 24V	T1 1.2 s T2 2.2 s T3 3.2 s T4 4.2 s	IN 0	Auto	
11	GATE11	Stop	OUT 24V	T1 1.2 s T2 2.2 s T3 3.2 s T4 4.2 s	IN 0	Auto	
12	GATE12	Stop	OUT 24V	T1 1.2 s T2 2.2 s T3 3.2 s T4 4.2 s	IN 0	Auto	
13	GATE13	Stop	OUT 24V	T1 1.2 s T2 2.2 s T3 3.2 s T4 4.2 s	IN 0	Auto	
14	GATE14	Stop	OUT 24V	T1 1.2 s T2 2.2 s T3 3.2 s T4 4.2 s	IN 0	Auto	
15	GATE15	Stop	OUT 24V	T1 1.2 s T2 2.2 s T3 3.2 s T4 4.2 s	IN 0	Auto	
16	GATE16	Stop	OUT 24V	T1 1.2 s T2 2.2 s T3 3.2 s T4 4.2 s	IN 0	Auto	
17	GATE17	Stop	OUT 24V	T1 1.2 s T2 2.2 s T3 3.2 s T4 4.2 s	IN 0	Auto	
18	GATE18	Stop	OUT 24V	T1 1.2 s T2 2.2 s T3 3.2 s T4 4.2 s	IN 0	Auto	
19	GATE19	Stop	OUT 24V	T1 1.2 s T2 2.2 s T3 3.2 s T4 4.2 s	IN 0	Auto	
20	GATE20	Stop	OUT 24V	T1 1.2 s T2 2.2 s T3 3.2 s T4 4.2 s	IN 0	Auto	
21	GATE21	Stop	OUT 24V	T1 1.2 s T2 2.2 s T3 3.2 s T4 4.2 s	IN 0	Auto	
22	GATE22	Stop	OUT 24V	T1 1.2 s T2 2.2 s T3 3.2 s T4 4.2 s	IN 0	Auto	
23	GATE23	Stop	OUT 24V	T1 1.2 s T2 2.2 s T3 3.2 s T4 4.2 s	IN 0	Auto	
24	GATE24	Stop	OUT 24V	T1 1.2 s T2 2.2 s T3 3.2 s T4 4.2 s	IN 0	Auto	
Tool:b		No Alarm		A:229V	B:229V	C:229V	2021/09/13 15:49:27

And Touch  [Temp] on Sequence Valve Gate Control main interface, then you can enter Temperature Control main interface.

**Notes:** 1) Zone's output type is selected on modules with jumpers.

2) Screw position's unit is mm or inch, selected in screw position's setup (calibration).

### 7.1 Control Modes

 [Auto]:

This type of control is an auto system and requires a start trigger signal.

The controller will wait until it receives the start trigger after which it starts the timer from zero-time position. From this point gates open and close according to the time or position settings that you have configured.

 [Manual]:

This type of control requires no start trigger signal.

Each gate can be opened or closed by Touching [ MANULE].

## 7.2 Start Trigger Modes

This Sequential Valve Gate controller supports gates open/close 1~2 times in a complete cycle.

If the start trigger duration time is longer than a complete cycle of gate open/close, then the control process is:

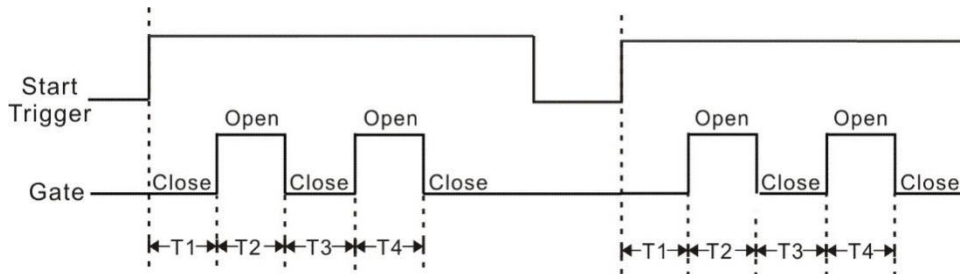

- 1) When the controller receives the start trigger, it initiates the run timer from the zero time position.
- 2) Gates open after T1 time (or screw position is T1) from the controller receives start trigger;
- 3) Gates close after T2 time (or screw position is T2) from the gates open;
- 4) Gates open again after T3 time (or screw position is T3) from the gates close;
- 5) Gates close after T4 time (or screw position is T4) from the gates open;
- 6) The controller waits a new start trigger.

If the start trigger time of duration is shorter than a complete cycle of gate open/close, then the control process has 4 modes selected by parameter "Input Type":

**Mode 0:** Once the gate open/close cycle starts, it will ignore the new start trigger until the cycle ends.

The control process is similar to the start trigger time of duration is longer than a complete cycle of gate. open/close.

Mode 0 (Input Type=0)

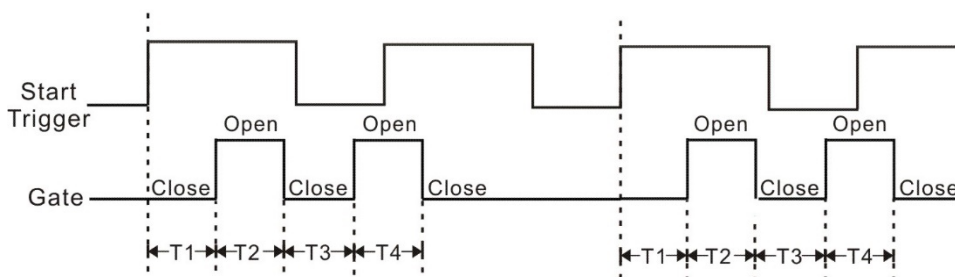

- 1) When the controller receives the start trigger, it initiates the run timer from the zero-time



position.

- 2) Gates open after T1 time (or screw position is T1) from the controller receives start trigger;
- 3) Gates close after T2 time (or screw position is T2) from the gates open;
- 4) Gates open again after T3 time (or screw position is T3) from the gates close.
- 5) Gates close after T4 time (or screw position is T4) from the gates open.
- 6) The controller waits a new start trigger.

**Mode 1:** The gate open/close cycle will be terminated and gate close when the start triggers end. The controller initializes the run timer when it receives the new start trigger.

Mode 1 (Input Type=1)

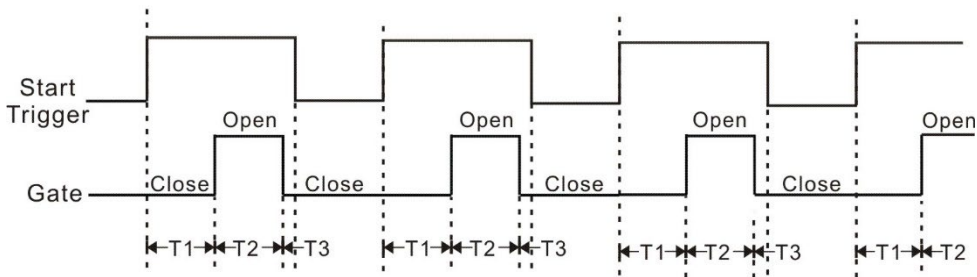

- 1) When the controller receives the start trigger, it initiates the run timer from the zero-time position.
- 2) Gates open after T1 time (or screw position is T1) from the controller receives start trigger;
- 3) Gates close after T2 time (or screw position is T2) from the gates open;
- 4) Gates open again after T3 time (or screw position is T3) from the gates close.
- 5) Gates close after T4 time (or screw position is T4) from the gates open.
- 6) In the control process, when the start triggers end, the gate open/close cycle will be terminated and gate close.
- 7) The controller waits a new start trigger.

**Mode 2:** The gate open/close cycle will be terminated and gate close when the new start trigger comes. The controller initializes the run timer when it receives the new start trigger.

Mode 2 (Input Type=2)

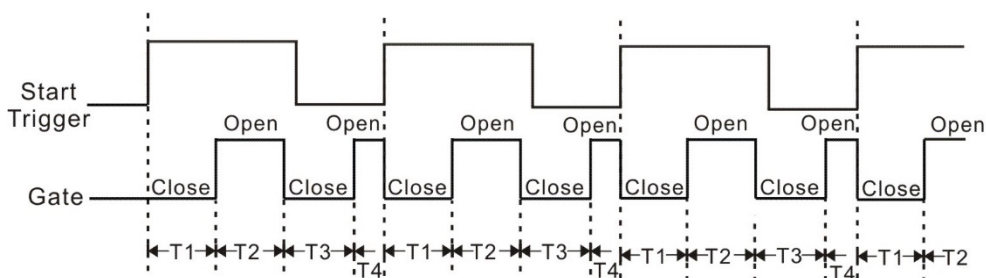

- 1) When the controller receives the start trigger, it initiates the run timer from the zero-time position.
  - 2) Gates open after T1 time (or screw position is T1) from the controller receives start trigger;
  - 3) Gates close after T2 time (or screw position is T2) from the gates open;
  - 4) Gates open again after T3 time (or screw position is T3) from the gates close.
  - 5) Gates close after T4 time (or screw position is T4) from the gates open.
  - 6) In the control process, when the new start trigger comes, the gate open/close cycle will be terminated and gate close.
- At the same time, the controller initializes the run timer to start a new gate open/close cycle.

**Mode 3:** The gate open/close cycle will be terminated and gate close when the new start trigger comes.

The controller initializes the run timer when it receives the next new start trigger.

Mode 3 (Input Type=3)

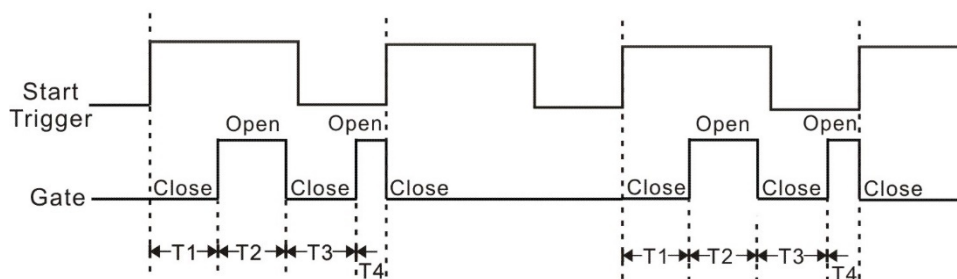

- 1) When the controller receives the start trigger, it initiates the run timer from the zero-time position.
- 2) Gates open after T1 time (or screw position is T1) from the controller receives start trigger;
- 3) Gates close after T2 time (or screw position is T2) from the gates open;
- 4) Gates open again after T3 time (or screw position is T3) from the gates close.
- 5) Gates close after T4 time (or screw position is T4) from the gates open.
- 6) In the control process, when the new start trigger comes, the gate open/close cycle will be terminated and gate close.
- 7) The controller waits the next new start trigger.

### 7.3 Gate Open/Close Trigger Modes

You have two main options that you can use to set up gate opening and gate closing times.

- 1) **Time value only**– if you have no ancillary sensors then your only choice for gate opening and closing is an internal timer.
- 2) **Screw Position** (and time) – if you have position sensors that detect screw ram position and feed it back via an analogue (0–10Vdc) input, then you can set gate open and close relative to screw position. You can also use a combination of screw position and time.

### 7.4 Detailed Parameters for Each Gate

Parameter	Description
T 1	Gate open delay time (or screw position) from the controller receives start trigger.
T 2	Gate open duration time (or screw position for gate closing).
T 3	Gate open again delay time (or screw position) from it close.
T 4	Gate open duration time (or screw position for gate closing).
Input Filter	Filter for start trigger, used to reduce the influence of interference. When it is too large, the controller cannot work normally.
Input Type	Start trigger modes.
Time unit	Time unit (sec)
Screw position	Screw position (mm/inch)

### 7.5 Gate Setup

Touch the Gate Status “Open” or “Close” on the main interface, then you can enter to Valve Gate Parameter Setting interface (different authority can see different parameters, and no parameter can be seen without login).



#### 7.5.1 Operator Login Status

- **Set T1 ~T4:**  
Touch the value to call up small keyboard.
- **Back to main interface:** Touch [Quit].

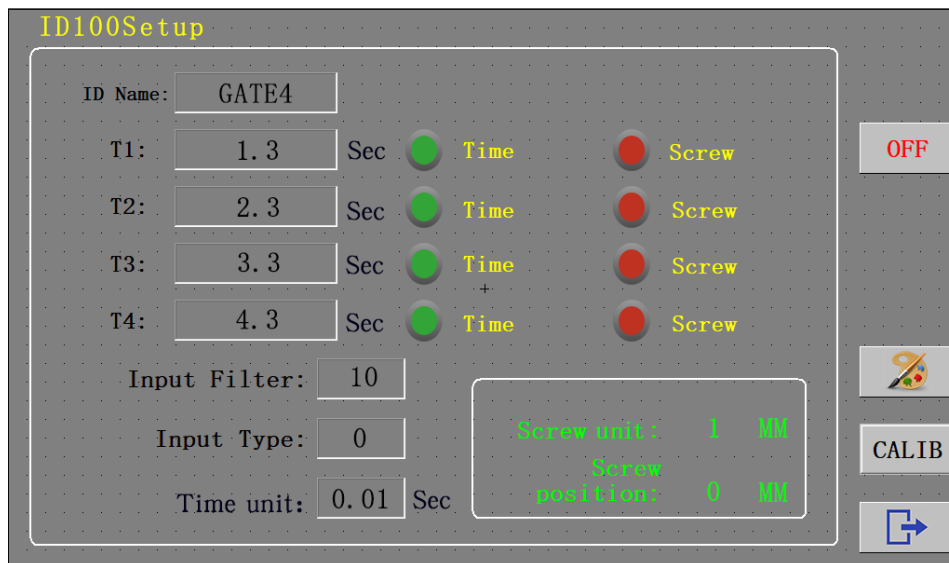

## 7.5.2 Engineer / Director / Administrator Login Status



- **ID name:** Touch it to call up small keyboard and rename the zone you want.
- **Select gate open/close trigger modes:**  
Touch the indicator of Time control or Screw control to select modes for T1~T4.  
 red- unchecked,  green - checked.
- **Set T1~T4:** Touch the value to call up small keyboard.
- **Input filter:** Touch the value to call up small keyboard to set input filter.
- **Input type:** Touch the value to call up small keyboard to set input type. (Refer to 7.2)
- **Time unit:** Touch the value to call up small keyboard, set 0.01, 0.1 or 1 sec.
- **Turn off or turn on this zone:** Touch **[OFF]** / **[ON]**
- **Select background color of this gate:** Touch  **[Color]** to call up background color window.

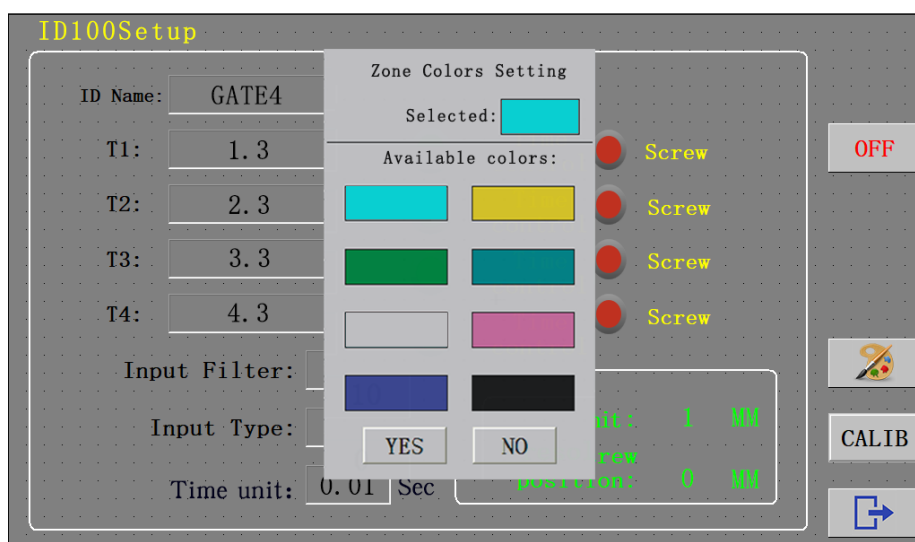

Select a color you want to use as background of this gate, and then Touch **[YES]** to set the figures and exit the interface.

- **Screw Position Setup:** Touch **CALIB** to call up screw position setup window.

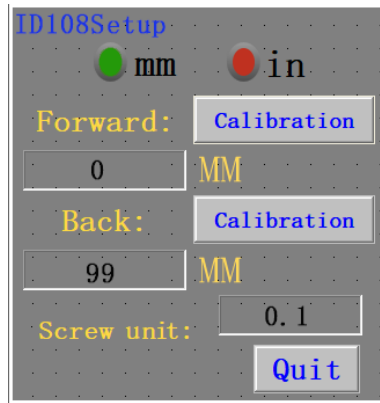

- 1) **Select screw unit:** mm or inch, (green  means checked. red is unchecked)
- 2) **Set screw position unit:** Touch the value to call up small keyboard, set 0.01, 0.1 or 1.
- 3) **Set screw forward & backward position:** Touch the value to call up small keyboard.
- 4) **Calibrate screw forward & backward position:**

push the screw to forward position and Touch **[Calibration]** of forward; next push the screw to its back position and Touch **[Calibration]** of backward.

If the upper limit or lower limit position is considered to be inaccurate, the calibration can be repeated. When calibration is done, Touch **[Quit]** to save the setting and exit the interface.

- **Back to main interface:** Touch  **[Exit]**.

## 7.6 Test

Touch **TEST** on the main interface to simulate a start trigger, then the controller will start a complete gate open/close cycle.

## 7.7 Preview the Setting

Touch  **[Graph]** on the main interface, and you can see the sequential chart of all gates open/close setting. You can compare and confirm the setting.

## Chapter 8 Run/Stop System

### 8.1 Run System

Touch  [Run] on the main interface to run the temperature control or SVG control system.

#### Temperature Control

All zones start to work in Auto mode (disable keep the data in system setting) or the mode before  
All temperature zones work in auto control mode when started, except for those turned off in temperature zone Settings.

**Note:** If you select save status data in system Settings, the working mode of each temperature zone after startup is the working mode before power-off.

- You can Touch  [Standby] on the main interface to make all zones work in Standby mode.
- You can make a specified zone work in Standby mode by single Zone Setting.
- You can make a specified zone work in Manual mode and set its power output by Zone Setting.
- You can Run or Stop a specified zone by Zone Setting.
- You can activate Boost or Auto-Tuning function for a specified zone by Zone Setting.
- You can Run or Stop a group zones with the same background color by Group Config.

#### SVG Control



All zones start to work in Auto mode.

You can Touch  [Manual] on the main interface to make all zones work in Manual mode.  
In Manual mode, you can open or close each gate by Touching [MANULE].

### 8.2 Stop System

Touch  [Stop] on the main interface of temperature control or SVG control to stop the system.

All modules stop working.

- You can stop a specified zone by Zone Setting.
- You can stop a group zone with the same background color by Group Config.
- Touches the start/stop button  of a temperature zone on the main control interface to stop the temperature zone individually.
- After selecting multiple temperature zones on the main control interface, Touch  [Stop] to stop only the selected temperature zone.